

# PTEN

PROFESSIONAL TOOL & EQUIPMENT NEWS

\$15.00 - July 2022  
Volume 33, Number 6

ENDEAVOR  
BUSINESS MEDIA



**Autel**  
Intelligent ADAS IA900WA  
Wheel Alignment and ADAS  
Calibration System  
Pg. 10



**Matco Tools**  
Maximus 4.0  
Diagnostic Scan Tool  
Pg. 10



**Streamlight**  
BearTrap  
Pg. 34



**Milwaukee Tool**  
M18 FUEL 15mm Random  
Orbital Polisher  
Pg. 4



**AIRCAT by  
Florida Pneumatic**  
115 Degree  
Angle Die Grinder  
Pg. 30

## 2022 PRODUCT SHOWCASE



**Launch Tech**  
Millennium MAX  
Pg. 17



**Mastercool**  
Dual EVAP/High Pressure Diagnostic Smoke Machine  
with Truck Adapter Accessory Kit, No. 43070  
Pg. 10



**BendPak**  
MDS-6EXT Mid-Rise Lift  
Pg. 34

**180+** PRODUCTS  
IN EIGHT CATEGORIES

# Get a professional level diagnostics tablet for less than a...



## PLATINUM S6



- Full system access
- Special features & coding
- Unbeatable domestic, Asian & European car & light truck coverage
- Compact and easy to handle design with built in VCI storage
- 28 service resets
- Bi-directional communication (optional)
- FREE vehicle software updates for lifetime of tool



# 43

scan here



GET A FREE  
PRODUCT  
GUIDE



2022 All Petty marks used under license from Petty IP,LLC.

WWW.THINKCARUS.COM | SUPPORT@THINKCARUS.COM | @THINKCARUS  
US Tech Support Ph: 833-692-2766 | Business Hours Mon - Fri 8am - 5pm PST

## THINKCAR

Circle 1 on card, or click "PTEN e-inquiry" on VehicleServicePros.com

Printed in the U.S. Volume 33, Number 6; July 2022

**EXECUTIVE VICE PRESIDENT – TRANSPORTATION**

Reggie Lawrence RLawrence@EndeavorB2B.com

**VP/GROUP PUBLISHER, ENDEAVOR VEHICLE REPAIR GROUP**

Kylie Hirko  
630-253-4034 Kylie@VehicleServicePros.com

**EDITORIAL DIRECTOR**

Amanda Silliker  
ASilliker@EndeavorB2B.com

**ASSOCIATE EDITOR**

Emily Markham  
920-234-6359 EMarkham@EndeavorB2B.com

**ASSOCIATE EDITOR**

Kayla Oschmann  
920-563-1764 KOschmann@EndeavorB2B.com

**TECHNICAL EDITOR**

Brandon Steckler

**ASSOCIATE SALES DIRECTOR**

Mattie Gorman-Greuel  
920-563-1636 MGorman@EndeavorB2B.com

**DIRECTOR OF BUSINESS DEVELOPMENT**

Cortni Jones  
920-568-8391 CJones@EndeavorB2B.com

**MULTIMEDIA ACCOUNT EXECUTIVE**

Diane Braden  
920-568-8364 DBraden@EndeavorB2B.com

**MULTIMEDIA ACCOUNT EXECUTIVE**

Lisa Mend  
949-259-5654 LMend@EndeavorB2B.com

**MULTIMEDIA ACCOUNT EXECUTIVE**

Michael Parra  
925-307-8779 MParra@EndeavorB2B.com

**MULTIMEDIA ACCOUNT EXECUTIVE**

Paul Ropski  
815-255-4118 PRopski@EndeavorB2B.com

**INSIDE SALES**

James Hwang  
801-823-1704 JHwang@EndeavorB2B.com

**PRODUCTION MANAGER**

Jane Pothlanski  
224-324-8507 JPothlanski@EndeavorB2B.com

**AD SERVICES MANAGER**

Carmen Seeber  
920-568-8373 CSeeber@EndeavorB2B.com

**ART DIRECTOR**

Tim Schafer

**LIST RENTAL REP**

Michael Costantino  
402-836-6266 Michael.Costantino@infogroup.com

**LIST RENTAL REP**

Kevin Collopy  
402-836-6265 Kevin.Collopy@infogroup.com

**AUDIENCE DEVELOPMENT MANAGER**

Debbie Dumke

**ENDEAVOR BUSINESS MEDIA, LLC**

CEO – Chris Ferrell

President – June Griffin

CFO – Mark Zadell

COO – Patrick Rains

Chief Administrative and Legal Officer – Tracy Kane

EVP/Group Publisher – Transportation – Reggie Lawrence

EVP Special Projects – Kristine Russell

EVP Marketing Solutions & Data – Jacque Niemiec

Subscription Customer Service  
877-382-9187; 847-559-7599

Circ.ProfDistmag@omeda.com

PO Box 3257 • Northbrook IL 60065-3257

Article reprints reprints@endeavorb2b.com

*Professional Tool & Equipment News* (USPS 012-426, ISSN 1081-4485 print; ISSN 2150-2072) is published ten times a year in February, March, April, May, June, July, August, September, October, and December by Endeavor Business Media, LLC, 1233 Janesville Avenue, Fort Atkinson, WI 53538. Periodicals postage paid at Fort Atkinson, WI 53538 and additional mailing offices. POSTMASTER: Send address changes to *Professional Tool & Equipment News*, PO Box 3257, Northbrook, IL 60065-3257. Canada Post PM0612608. Return undeliverable Canadian addresses to: *Professional Tool & Equipment News*, PO Box 25542, London, ON N6C 6B2.

Subscriptions: Individual subscriptions are available without charge in the U.S. to qualified subscribers. Publisher reserves the right to reject non-qualified subscriptions. Subscription prices: U.S. \$50 per year, \$93 two year; Canada/Mexico \$72 per year, \$131 two year; All other countries \$105 per year, \$195 two year. All subscriptions payable in U.S. funds, drawn on U.S. bank. Canadian GST#842773848. Back issue \$10 prepaid, if available. Printed in the USA. Copyright 2022 Endeavor Business Media, LLC.

All rights reserved. No part of this publication may be reproduced or transmitted in any form or by any means, electronic or mechanical, including photocopy, recordings or any information storage or retrieval system, without permission from the publisher.

Endeavor Business Media, LLC does not assume and hereby disclaims any liability to any person or company for any loss or damage caused by errors or omissions in the material herein, regardless of whether such errors result from negligence, accident or any other cause whatsoever. The views and opinions in the articles herein are not to be taken as official expressions of the publishers, unless so stated. The publishers do not warrant, either expressly or by implication, the factual accuracy of the articles herein, nor do they so warrant any views or opinions offered by the authors of said articles.



**4**  
**BODY SHOP**



**10**  
**DIAGNOSTICS**



**20**  
**HARDLINES**



**28**  
**PERSONAL GEAR**



**30**  
**POWER TOOLS & AIR TOOLS**



**34**  
**SHOP EQUIPMENT, STORAGE & SUPPLIES**



**46**  
**UNDERHOOD/ POWERTRAIN**



**48**  
**UNDER VEHICLE, SUSPENSION & BRAKES**

## It's like Christmas in July ... the joy of new tools and equipment!



**KAYLA OSCHMANN**  
ASSOCIATE EDITOR  
[koschmann@endeavorb2b.com](mailto:koschmann@endeavorb2b.com)

We know shop owners and technicians love new tools and equipment ... and so do we! They don't just make work life easier and look nice in the toolbox, but they can help get vehicles out of the bay faster and, well, new tools and equipment are exciting to buy.

Whether you're a recent grad looking to start your collection, or have been in the field for awhile

and want to add to your already abundant arsenal of tools, new is fun. Or you're simply just curious to see what has been recently introduced in the industry, we have you covered.

Unlike our other issues, our July Product Showcase issue is strictly products. It's chocked full of product releases in eight categories.

So, go ahead and flip through the pages. I bet something will catch your eye! ☒

## FOLLOW US ON SOCIAL



SPONSORED

Circle 2 on card or click "PTEN e-inquiry" on VehicleServicePros.com

## FEATURED PRODUCT



### FORMING PANELS AT A DISTANCE

Designed to solve the age-old problem of hitting things at a distance, **Tool Aid's 89360 5-pc Body Forming Punch Set** features five of the most popular head profiles to knock those panels into shape. Each punch head is polished and heat treated for increased hardness and corrosion resistance, and the 12" overall length makes reaching recessed panels and structural

members a breeze. A perfect set for precision and strength at a distance. ■



**TOOL AID** JOIN OUR LIST  
**TOOL AID**®  
 TOOLS FOR THE PROFESSIONAL  
 TEXT TOOLAID TO 22828

**S&G Tool Aid Corp.**

973-824-7730

toolaid.com



### FEATURES A CLOG-RESISTANT COATING

The **Mirka Galaxy Abrasive** is a multi-purpose, precision grain abrasive engineered to deliver long lasting, edge-to-edge sanding efficiency. The Galaxy line is ideal for tough applications, including hard surface sanding for marine, composite, automotive, and wood applications. In addition to the ceramic self-sharpening grains, the product features a clog resistant coating, a film backing, and ideal grain adhesion. The Galaxy line is offered in a wide range of sheets and discs, from coarse 40 grit to fine 2000 grit, and is available with Mirka's Multifit universal hole patterns. ■

Circle 3 on card or click "PTEN e-inquiry" on VehicleServicePros.com



### COMPLETE KIT FOR RIVETING AND ADHESIVE JOBS IN ONE VERSATILE UNIT

The **Pro Spot International PR-5 Mobile Riveting and Bonding Station** comes complete with drawers, bonding tools storage space, heavy duty casters, on-board tool storage, a PR-5 riveter, 55mm and 80mm arms, a blind rivet adapter, a charging station, two Li-ion batteries, the Ford F series die kit, and an Android tablet filled with videos, animations, and instructions. The station has two 110V power outlets, four USB outlets, and two compressed air outlets. It also has a convenient built-in PR-5 riveter tool holder on the work surface. ■

Circle 4 on card or click "PTEN e-inquiry" on VehicleServicePros.com



### COMPATIBLE WITH PUSH-PULL GUNS

The **Miller Electric Millermatic 355 MIG Welder** is an easy-to-use power source designed for welders of any skill level. It can operate on single-phase or three-phase AC power and provides MIG and pulsed MIG capabilities for mild steel, aluminum, and stainless steel in thicknesses, from 22 gauge to 1/2". The Millermatic 355 has a 7" LCD user interface and is compatible with push-pull guns. With Auto-Set Elite, welders can easily select the right parameters to produce high-quality welds. It also features a program mode where welders can save up to four frequently used weld processes in the machine. ■

Circle 5 on card or click "PTEN e-inquiry" on VehicleServicePros.com



### PROVIDES ALL-DAY COMFORT AND CONTROL

The **Milwaukee Tool M18 FUEL15mm Random Orbital Polisher**, No. 2684-22HD, delivers between 2,650 and 5,100 rpm and features an eight-position speed dial. With over 2" of battery clearance, the battery-powered polisher gives operators assurance that their work surface is protected from dents and scratches. The tool also provides ideal balance and grip ergonomics to deliver all-day comfort and control. The polisher produces low levels of vibration and noise, allowing users to hold the tool comfortably for longer periods of time, decreasing user fatigue and increasing daily productivity. ■

Circle 6 on card or click "PTEN e-inquiry" on VehicleServicePros.com

# INCREASE YOUR PROFITABLE REPAIRS

POWERFUL HARDWARE + EXPANDED SOFTWARE AT THE CORE! **MS906PRO**



**V200**  
No CAN FD  
Adapter Needed



## MS906PRO-TS EXCLUSIVE SOFTWARE

- Enhanced TPMS Status Screen
- Four 1-Sensor Programming Options
- Activate, Read & Relearn All Sensor Brands
- Batch Programming up to 20 1-Sensors

## NEW SOFTWARE FEATURES

- ADAS Calibration Capability\*
- Battery Analysis Capability\*
- Scan VIN: Text/Barcode Recognition with Camera
- Camera-Based License Plate Scan Recognition
- Advanced ECU Coding & Adaptions
- Customer Diagnostic Reports / Print & Save Easily

\*Additional Purchase Required

## UPGRADED HARDWARE

- 8" Touchscreen / Includes VCI200
- Octa-Core Processor / 128G Memory / 4G RAM
- 5MP Front & 16MP Rear Camera



- Pre/Post Scan Reports
- Customer Vehicle Data

Circle 7 on card or click "PTEN e-inquiry" on [VehicleServicePros.com](http://VehicleServicePros.com)

SUPPORT: 1.855.288.3587

EMAIL: [USSUPPORT@AUTEL.COM](mailto:USSUPPORT@AUTEL.COM) | WEB: [AUTEL.COM](http://AUTEL.COM)

VIEW MARKETING MATERIAL: [ISSUU.COM/AUTEL2](http://ISSUU.COM/AUTEL2)

FOLLOW US @AUTELTOOLS    



**AUTEL**

SPONSORED

Circle 8 on card or click "PTEN e-inquiry" on VehicleServicePros.com

## FEATURED PRODUCT

### DESIGNED TO MEET FORD REQUIREMENTS

The **Killer Tools Aluminum Stud Welder**, No. ART401F, is designed to meet Ford requirements. The system uses a powerful digital capacitor discharge stud welder. With dual inline ground handle and 12' cables to reach most roof repairs. The system comes with 4mm and 6mm aluminum studs, 4mm and 6mm stud pulling eye-nuts, 4mm and 6mm electrodes, t-handle pulling hook, lever puller, non-contact digital thermometer, and heat gun. Also comes with a five year limited warranty. ■



**Killer Tools**  
916-988-2289  
killertools.com

### INCLUDES ALL PRO-MAX ATTACHMENTS AND A HEAVY DUTY CART

The **Inductor Pro-Max Fully Loaded** from **Induction Innovations** uses high-frequency magnetic fields to generate invisible heat to easily remove parts bonded to metal. In seconds, users are able to release seized hardware from corrosion or thread lock compounds and other adhesives without damage and safety risks of an open flame, the company says. The Pro-Max Fully Loaded includes the Pro-Max induction heating system, along with ergonomically designed attachments, some molded in high temp, impact, and chemical resistant epoxy polymers. It also features a heavy duty cart made of 22 gauge steel and powder coat finish. ■

Circle 10 on card or click "PTEN e-inquiry" on VehicleServicePros.com



### HAS A VARIABLE SPEED CONTROL TRIGGER AND DIAL

The **Makita 40V Max XGT Brushless Cordless 7" Polisher** is designed to provide a cordless solution for a variety of polishing applications. It features a brushless motor with a variable speed control trigger and dial, offering zero to 2,200 rpm, enabling the user to match the speed to the application. The polisher includes a rubberized soft grip that provides increased comfort on the job, a top handle above the pad that allows the user to apply varying amounts of pressure depending on the application, and a rubberized over molding on the tool and battery position to help protect delicate surfaces. ■

Circle 11 on card or click "PTEN e-inquiry" on VehicleServicePros.com



### IMPROVES EFFICIENCY AND CLEANLINESS

The **3M Cubitron II Net Discs** are designed to get the job done sooner with fast-cutting and long-lasting net abrasive discs. The product helps dust extractors perform their best and delivers an ideal cut without sacrificing dust capture, the company says. They also leave virtually no dust on the work surface and in the environment, improving the overall efficiency and cleanliness of body shops. ■

Circle 9 on card or click "PTEN e-inquiry" on VehicleServicePros.com



### IDEAL FOR TIME-INTENSIVE COATING PROCESSES

The **SATAjet K 1800 Spray Mix** from **SATA Spray Equipment** is suited for a wide range of applications in various sectors, including the automotive industry to machinery, steelwork, and more. With its spray mix technology, the paint material is applied at ultra-high pressure, creating a pre-formed airless spray fan. Through the air cap, compressed air is fed to this airless spray fan, which helps to shape it and enables an even droplet distribution, the company says. It features a two-part clampLock paint needle system for easier maintenance and a single-axis trigger system for fatigue-free working. The lightweight spray gun is ideal for continuous and time-intensive coating processes. Available in three versions and with different nozzle sizes. ■

Circle 12 on card or click "PTEN e-inquiry" on VehicleServicePros.com



FOR MORE INFORMATION ON THESE PRODUCTS,  
CLICK ON "PTEN E-INQUIRY"  
at [VehicleServicePros.com](http://VehicleServicePros.com)  
OR CIRCLE THE NUMBER ON THE CARD.



### FEATURES AN LED WORKLIGHT

The **Marson BT-5 Battery Powered Riveter** from **Howmet Fastening Systems** is designed to deliver reliable performance at a valuable price point. The BT-5 is lightweight and offers an ergonomic grip. It also features an LED worklight and has a stroke length of .866". The Marson BT-5 kit includes nose tips for 1/8", 5/32", and 3/16" rivet diameters. An optional nosepiece allows users to install 3/32" rivets as well. ■

Circle 13 on card or click "PTEN e-inquiry" on [VehicleServicePros.com](http://VehicleServicePros.com)



### OFFERS DUAL-VOLTAGE 120/230V FLEXIBILITY

The **ESAB EMP 210 MIG/Stick/TIG Welder** is lightweight and offers dual-voltage input power flexibility, giving ideal portability for around the shop. The multi-process MIG/flux cored/stick/lift TIG welding system has a 10-200A output, a stable lift TIG arc at low amperage for finesse welds, and the power to run stick electrodes up to 5/32", including 7018. Additionally, it features a large easy-to-read LED display with digital controls for fast and accurate operation and can run off a generator with a 10 kVA output. ■

Circle 15 on card or click "PTEN e-inquiry" on [VehicleServicePros.com](http://VehicleServicePros.com)

SPONSORED

Circle 14 on card or click "PTEN e-inquiry" on [VehicleServicePros.com](http://VehicleServicePros.com)

## FEATURED PRODUCT

### PRODUCES A FINE, SWIRL-FREE FINISH

The **Ingersoll Rand 5100 Series Random Orbital Sander** is a powerful and versatile sander. It shines across auto body repair applications, general industrial, and maintenance, repair, and operations (MRO) jobs due to its comfort, durability, and performance. Its randomized orbits tackle a range of applications, including removing heavy material to fine finishing. With a dependable sander offering a maximum removal rate on each job, technicians can complete more work in a day. ■



**Ingersoll Rand**  
800-483-4981  
[ingersollrand.com](http://ingersollrand.com)

### MOBILE AND FEATURES A SMALL FOOTPRINT

The **Car-O-Liner CDR1 Workstation** contains the equipment and materials needed to perform light-to-medium collision damage repair quickly and efficiently. The CDR1 is mobile and has a small footprint. It features the CR235 Combi Spotter, which has two separate guns for easy switching between steel and aluminum welding operations. The workstation is available in three versions. The Level 1 cart includes the CR235 Combi Spotter, plus separate drawers with steel and aluminum repair tools, and the Level 2 cart features an additional drawer for glue pull repairs. The Level 3 cart includes a drawer for pneumatic push pull repairs, plus another drawer for holders. ■

Circle 16 on card or click "PTEN e-inquiry" on [VehicleServicePros.com](http://VehicleServicePros.com)



### KEEPS TOOLS SECURE AND ORGANIZED

The **Dent Fix Equipment RivMAX Riveting Repair Station**, No. DF-SPR70DX, is designed to keep all riveting tools in one mobile cabinet. With foam inserts and a lockable cart, technicians are able to organize and secure their tools and rivets. The station features the company's 10T Riveter, No. DF-SPR70, an automatic air powered riveter designed to perform common riveting tasks in modern body shops, including self-piercing rivets, blind rivets, and standard flow form rivets. It also includes many optional accessories, such as the Ford die set, medium sized arm, blind rivet adapter, and rivet assortment kit. ■

Circle 17 on card or click "PTEN e-inquiry" on [VehicleServicePros.com](http://VehicleServicePros.com)



SPONSORED

Circle 18 on card or click "PTEN e-inquiry" on VehicleServicePros.com

## FEATURED PRODUCT

### ERGONOMICS FOR DENT REPAIR



The **Killer Tools Steel Dent Puller with Ergonomically Designed Seated Cart**, Nos. ART38Special-110 and ART38Special-220, puts the technician in the perfect position to repair the majority of dents since 90 percent of dents are from bumper impacts, which are at a seated height. The dent puller easily fits underneath the cart. The electrode dent pullers are available in 110V and 220V, and come with a voltage conversion kit to fit the requirements of the user. Complete with shrinking/wiggle wire electrode, wiggle wire, slide hammer, long electrodes, and wiggle wire pulling claw. Exclusive 10-year limited warranty and made in the U.S.A. ■



**Killer Tools**  
916-988-2289  
killertools.com



### FEATURES AN INTEGRATED SPEED CONTROL

The **Dynabrade 3" Mini-Dynorbital Extreme Random Orbital Sanders** feature an integrated speed control, allowing the operator to adjust the rpm of the tool for artistic results. With a 3" pad size, the sanders help focus sanding small targeted areas. Its smaller grip gives greater control over the sanding surface and is helpful in hard-to-reach locations, the company says. The 3" sanders are 35 percent lighter than the company's 5" and 6" Extreme models, helping to reduce fatigue during extended usage. Available in four models: No. X31, X31V, X32, and X32V. Vacuum models are equipped with a 3/4" threaded, swiveling vacuum cuff for connection to Dynabrade clean air solutions. ■

Circle 19 on card or click "PTEN e-inquiry" on VehicleServicePros.com

### ELECTRONICALLY CONTROLLED TEMPERATURE AND AIR FLOW RANGE

The **Hazet 6-pc Heat Gun Set**, No. 1990N/6, features a soft touch grip zone for user comfort. With an even distribution of weight, the device can be placed upright safely in the standby position. Both the temperature range and air flow range are electronically controlled, are continuously adjustable, and includes five pre-programmed and configurable storage positions. The heat gun also offers an easy-to-read LCD display, fine-mesh dust protection filter to effectively reduce minute floating particles, and a power safety function (eco mode) to reduce energy and noise level. The set includes the heat gun, four nozzles, and a 30mm wide pressure roller. ■



Circle 20 on card or click "PTEN e-inquiry" on VehicleServicePros.com

### FEATURES A LOW WEIGHT COMPOSITE DESIGN

The **AIRCAT 6315-K Mini Orbital Sander Kit** combines the speed and power of a traditional sander. The tool features a low-weight composite design at only 1.58 lbs., and a convenient top mounted forward/reverse switch to provide easy one-handed directional changes. The kit features a sander, 2" and 3" hook and loop pads, and an assortment of 2" and 3" sandpaper in a blow molded storage tray. ■



Circle 21 on card or click "PTEN e-inquiry" on VehicleServicePros.com

### 1/2" THICK CUTTING CAPACITY

The **Forney Industries 40 P Plasma Cutter**, No. 440, is a 40A plasma cutter, featuring 120V/240V input power, and a 1/2" thick cutting capacity. The machine can be used to cut mild steel, aluminum, stainless steel, and more. The 20' torch allows for greater reach, and the internal air pressure control helps users maintain the right pressure. Additional accessories include a 15' ground clamp with a cable, a 15' input cable, and extra contact tips. ■



Circle 22 on card or click "PTEN e-inquiry" on VehicleServicePros.com



FOR MORE INFORMATION ON THESE PRODUCTS,  
CLICK ON "PTEN E-INQUIRY"  
at [VehicleServicePros.com](http://VehicleServicePros.com)  
OR CIRCLE THE NUMBER ON THE CARD.

### INCLUDES FIVE DIFFERENT 5 X 20CM WELDING RODS



The **Portasol Pz50 Plastic Welding Kit** is ideal for technicians for use on broken bumper tabs, headlight brackets, and small dent repairs. It's also ideal for body shops to use and complement other plastic welding repair methods and tools, such as smoothing a raised weld, and performing small intricate repairs where larger tools are not suitable to carry out the repair. The kit includes five different 5 x 20cm welding rods (universal, ABS, PP, PE, and PS), reinforcement grid, and instructions. All components fit within a handy case. ■

Circle 23 on card or click "PTEN e-inquiry" on [VehicleServicePros.com](http://VehicleServicePros.com)



### SWITCHING SPEEDS OF 1/25,000 OF A SECOND

The **TRANSLIGHT 555 + Premium Auto Darkening Helmet** from **Jackson Safety** features the company's 370 series Easy Grip Turn ratcheting mechanism and a 12.47 sq. in. viewing area. The viewing area offers switching speeds of 1/25,000 sec. to increase comfort and keep eyes less fatigued. It also has a True Color ADF 1/1/1/1 optical clarity rating, and four arc sensors to provide ideal coverage when welding out of position. The helmet's proprietary external shade adjuster finely tunes in .2 increments or +/- 1 full shades for visual precision. Additionally, it has an external grind button to allow user's to switch modes with ease. ■

Circle 25 on card or click "PTEN e-inquiry" on [VehicleServicePros.com](http://VehicleServicePros.com)

SPONSORED  
Circle 24 on card or click "PTEN e-inquiry" on [VehicleServicePros.com](http://VehicleServicePros.com)

## FEATURED PRODUCT



### NITRO-FUZER NITROGEN PLASTIC WELDERS FROM POLYVANCE

**Polyvance** pioneered nitrogen plastic welding in the auto collision repair industry in 2006 and continues its innovation with the patent-pending, sixth-generation **8200 Series Nitro-Fuzer Welders**. Featuring digital temperature control, flow control, and with a low-pressure safety cutoff switch, the latest Nitro-Fuzers have everything you need to start repairing virtually any automotive plastic, including bumper fascia, headlight tabs, fan shrouds, rocker panel moldings, and so on. Reduce cycle time and increase profit by repairing more plastic. ■

**Polyvance**  
ADVANCING POLYMER REPAIR

**Polyvance**  
800-633-3047  
[polyvance.com](http://polyvance.com)



## Self-Piercing Riveter

- ✓ Rivet aluminum panels with 6 tons (13,500 lbs) of force
- ✓ Cold forming process requires no heat and no pre-drilled holes
- ✓ Used for self-piercing, flattening, hole punching, and rivet removal
- ✓ Completely cordless solution



Video

[HSAUTOSHOT.COM](http://HSAUTOSHOT.COM)



FOLLOW US @HSAUTOSHOT



FOR MORE INFORMATION ON THESE PRODUCTS, CLICK ON "PTEN E-INQUIRY" at [VehicleServicePros.com](http://VehicleServicePros.com) OR CIRCLE THE NUMBER ON THE CARD.

SPONSORED

Circle 27 on card or click "PTEN e-inquiry" on [VehicleServicePros.com](http://VehicleServicePros.com)

## FEATURED PRODUCT



### 2-IN-1 ADAS AND WHEEL ALIGNMENT

The **Autel Intelligent ADAS IA900WA Wheel Alignment and ADAS Calibration System** offers both wheel

alignment and ADAS calibration. Software includes illustrated alignment instructions, live readings,

required tools, and adjustment locations display. Six high-resolution positioning and tracking cameras automatically monitor the vehicle height on a

shop lift. Robotic frame movement allows greater efficient and alignment reading accuracy to 0.02 degrees. IA900WA system includes steering wheel lock, wheel chocks, and additional accessories. ■

# AUTEL®

**Autel**  
855-288-3587  
[youtube.com/watch?v=Zi54Gsh4ZjQ](https://www.youtube.com/watch?v=Zi54Gsh4ZjQ)



### INCLUDES A FOUR-CHANNEL OSCILLOSCOPE AND BATTERY ANALYZER

The **Matco Tools Maximus 4.0 Scan Tool** features a 13.3" screen, FCA security gateway access, CAN FD, battery analyzer, four-channel scope, carline software, and MaxFix. The included Bluetooth battery tester enables technicians to identify battery system issues quickly. Technicians can also receive Tech 2 Tech Remote diagnosis with the ability to consult and collaborate with expert technicians remotely for information sharing and identifying complex issues and repairs. ■

Circle 28 on card or click "PTEN e-inquiry" on [VehicleServicePros.com](http://VehicleServicePros.com)



### BUILT-IN INTERNAL COMPRESSOR FOR MOBILE REPAIRS

The **Mastercool Dual EVAP/High Pressure Diagnostic Smoke Machine with Truck Adapter Accessory Kit**, No. 43070, is

designed for EVAP, turbo/intake, and heavy duty truck

testing. With an internal compressor, mobile repairs are made possible. The smoke machine kit includes all the adapters for EVAP, high pressure, and heavy duty truck testing. ■

Circle 29 on card or click "PTEN e-inquiry" on [VehicleServicePros.com](http://VehicleServicePros.com)



### FEATURES A FULL DATABASE OF INDIRECT, MANUAL, AND AUTO RELEARN PROCEDURES

The **Mac Tools TPMS Tool**, No. ET3450, features a full database of indirect, manual, and auto relearn procedures. The tool has the ability to activate and read TPMS sensor data, program sensors, check remote keyless entry (RKE) signal, and display sensor data in seconds. The scanner performs OBD-II relearns within minutes when paired with a compatible Mac Tools diagnostic scan tool and has an intuitive, full-color display with easy vehicle lookup by make, model, and year. A two year warranty, and four years of software updates are included. ■

Circle 31 on card or click "PTEN e-inquiry" on [VehicleServicePros.com](http://VehicleServicePros.com)

### A UNIVERSAL DIAGNOSTIC LIGHT TESTER FOR TRAILERS

The **Innovative Products of America Smart MUTT X**, No. 4105, is a universal, remote-controlled, diagnostic light trailer for all North American trailers. The unit is ideal for semi, RV, utility, boat, and horse trailer-type connections. It's able to test five of the most common trailer types, including 7-way flat (spade), 7-way round, 6-way round, and 5-pin and

4-pin connections. The Smart MUTT X is micro-processor controlled and can be electronically switched to different trailer-type modes. Each mode optimizes system programming by pin type to simplify and speed up inspections. It includes a large processor for future expandability and a 12-button remote. ■

Circle 30 on card or click "PTEN e-inquiry" on [VehicleServicePros.com](http://VehicleServicePros.com)





## AN ALL-IN-ONE SOLUTION FOR SCANNING, DIAGNOSTICS, AND CALIBRATIONS

The **asTech Duo** is designed to be an all-in-one solution for scanning, diagnostics, and calibrations, simplifying vehicle repair for professionals in the automotive collision, mechanical, and dealership sectors. Users have access to both remote OEM scans and local OEM-compatible scans, all within the same asTech device. ■

**Circle 32 on card or click "PTEN e-inquiry" on VehicleServicePros.com**



## INCLUDES VISUAL ENHANCEMENTS TO THE SOFTWARE'S INTERFACE

Noregon's latest **JPRO Professional 2022 v1 Update** includes additional support, coverage, and bidirectional tests for major component and vehicle manufacturers, plus visual enhancements to the software's interface. Building on JPRO's educational features, users can now view short tech tip videos while the application gathers vehicle data upon a connection. Active subscribers can update JPRO for no charge via a prompt in the application when they have an active internet connection or manually update online. ■

**Circle 34 on card or click "PTEN e-inquiry" on VehicleServicePros.com**

SPONSORED  
**Circle 33 on card or click "PTEN e-inquiry" on VehicleServicePros.com**

## FEATURED PRODUCT

### HEAVY DUTY GATOR CLIPS PROVIDE SECURE CONNECTION

The **Lisle Corporation Relay Pro 12-24V**

**Relay Tester**, No. 60150, tests relays by simply clipping the test leads onto the relay terminal pins using a 12V or 24V DC power source. It tests a wide range

of four and five pin relays including shielded, non-shielded, relays with different pin sizes, and four pin normally closed relays that other testers may incorrectly show fail. The tester automatically determines the relay configuration so the fully insulated gator clips can be connected in any order. Eliminates guesswork because you don't need to connect to specific pins, like other testers. 45" power leads with heavy duty gator clips provide a secure connection to the power source. ■



**Lisle Corporation**  
 712-542-5101  
 lislecorp.com

### REMOTE PLATFORM WITH OEM-TRAINED TECHNICIANS

The **Opus IVS DrivePro Remote and DrivePro Remote Unlimited** is a remote platform with OEM-trained technicians designed to help users through tough applications. The DrivePro Remote features pay-per-use IVS 360 Live Expert Support for on-demand remote access to 100+ OEM-brand-specific master technicians, IVSRAP,

and IVSRepair, a complete multi-brand aftermarket diagnostic suite. The DrivePro Remote Unlimited version includes all DrivePro Remote features, plus unlimited access to IVS 360 support, the complete Autologic Legacy European Software, and a docking station. ■

**Circle 35 on card or click "PTEN e-inquiry" on VehicleServicePros.com**



### UTILIZES AN ON-BOARD MICRO AIR COMPRESSOR

The **Bosch SMT 500 Leak Tester** is designed to find all kinds of leaks in automotive applications, including vacuum, EVAP exhaust, oil, manifolds, EGR valves, seals, gaskets, brake vacuum hoses, cooling systems, wind and water leaks, and more. Utilizing an on-board micro air compressor, the SMT 500 eliminates the need for an external compressed shop air source, so technicians can quickly diagnose, locate, and repair leaks whether the repair job is across the service bay or across town. The variable flow control and OEM-approved smoke agent can help detect leaks as small as 0.01" in low pressure sealed systems. ■

**Circle 36 on card or click "PTEN e-inquiry" on VehicleServicePros.com**





FOR MORE INFORMATION ON THESE PRODUCTS, CLICK ON "PTEN E-INQUIRY" at [VehicleServicePros.com](http://VehicleServicePros.com) OR CIRCLE THE NUMBER ON THE CARD.

SPONSORED

Circle 37 on card or click "PTEN e-inquiry" on [VehicleServicePros.com](http://VehicleServicePros.com)

## FEATURED PRODUCT

### FCA SECURE GATEWAY COMPATIBLE

**ADASLink** from **Hunter Engineering** is a premium, full-diagnostic scan tool that includes ADAS calibration and secure FCA gateway capabilities, enabling shops to take control of this challenging work by decreasing steps, increasing efficiency, and cutting calibration time in half. This complete solution integrates with Hunter's WinAlign software, providing the technician with quick access to specific calibration procedures for more than 25 million vehicles. ADASLink guides the technician with step-by-step onscreen instruction, ensuring the calibration is completed accurately. ■



**HUNTER**  
Engineering Company

Hunter Engineering Co.  
314-731-0000  
[hunter.com/ADAS](http://hunter.com/ADAS)



### RUNS PROFESSIONAL-GRADE FULL SYSTEM SCANS

The **OTOFIX D1 Diagnostic Tablet** is a professional-grade all-in-one handheld tool to read, analyze, and clear diagnostic trouble codes; reset steering angle sensors, service mileage, and service intervals; relearn parking brake-pad positioning; test and register a battery, and more. Powered by the OTOFIX cloud services app, users have access to data backups, past diagnostics history, and online solutions backed by OTOFIX Support. The OTOFIX D1 is built on an Android tablet and features a 7" touchscreen. ■

Circle 38 on card or click "PTEN e-inquiry" on [VehicleServicePros.com](http://VehicleServicePros.com)

### COMPARES TWO CIRCUITS AT THE SAME TIME

**DYVO** is a circuit and component tester designed for automotive circuits and all other 12V systems. It can easily find opens, shorts, and resistance issues. Its automatic load test identifies wire and circuit problems. DYVO can quickly compare two circuits at the same time and offers technicians to see live battery voltage during testing. It also alerts when battery voltage drops too low or too high. ■



Circle 39 on card or click "PTEN e-inquiry" on [VehicleServicePros.com](http://VehicleServicePros.com)



### FOR 2010 AND NEWER FORD, LINCOLN, AND MERCURY VEHICLES

The **Ford Rotunda VCM Lite** (vehicle communications module lite) is a diagnostic tool that allows vehicle diagnosis with the Ford DiagNow mobile app, available on Apple and Android devices. The small tool allows technicians to read and clear diagnostic trouble codes, view the vehicle network monitor, visualize vehicle parameters with Datalogger, and more on 2010 and newer Ford, Lincoln, and Mercury vehicles. ■

Circle 40 on card or click "PTEN e-inquiry" on [VehicleServicePros.com](http://VehicleServicePros.com)

SPONSORED

Circle 41 on card or click "PTEN e-inquiry" on [VehicleServicePros.com](http://VehicleServicePros.com)

## FEATURED PRODUCT

### ALIGNMENT CHECK AND FLOOR COMPENSATION BY TRU-POINT



The **John Bean Tru-Point** advanced driver assistance system calibration tool builds the vehicle in a 3-D space, maps the vehicle's contact points on the shop floor, and compensates for an uneven surface, and recognizes the targets, radars, and other ADAS accessories in this space, allowing the vehicle to calibrate on or off an alignment rack. Tru-Point provides a full geometric and mechanical vehicle check for ADAS-related OEM alignment values and frame straightness while monitoring each step of the setup process, and proper target placement procedures, preventing the user from incorrectly calibrating ADAS components by notifying when an error is found. ■

**John Bean**

John Bean  
800-362-4618  
[mytru-point.com](http://mytru-point.com)



### AVAILABLE IN SEVEN DIFFERENT KITS

The **FLIR VS80 High Performance Videoscope** is outfitted with a 1024 by 600 high resolution 7" touchscreen display and is available in seven different kits with the option to purchase probes that can be easily swapped in and out. Probe options include a 4.5mm diameter two-way articulating probe, a four-way articulating probe, a plumbing spool probe with a 25m cable, single HD and dual HD visible camera probes, a standard definition probe, and a general-purpose thermal camera probe. ■

**Circle 42 on card or click "PTEN e-inquiry" on VehicleServicePros.com**



### ADDITION OF THE ADAS QUICK REFERENCE TOOL

The latest **ALLDATA Repair and Collision Update** added the ADAS Quick Reference tool to its OEM repair information products. By clicking on ADAS Quick Reference, users are now taken to vehicle-specific ADAS information in ALLDATA Repair or ALLDATA Collision. The quick reference feature links directly to the ADAS system/component by name, provides the location of the component that may have been damaged in a collision, identifies component removal/replacement that could result in extra labor for calibration or sublet costs based on procedure complexity, and includes basic calibration information, required tools, and prerequisites for servicing ADAS components. ■

**Circle 43 on card or click "PTEN e-inquiry" on VehicleServicePros.com**

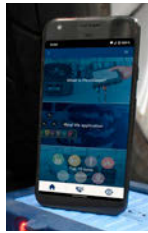

### OFFERS TIPS ON HOW TO USE PICO SCOPE

The **PicoScope Automotive App** from **Pico Technology** is designed to provide new users everything they need to understand PicoScope no matter the level of their diagnostic experience. The app allows users to learn about the different kits available, the use of their top 10 guided tests, and tips on how to use PicoScope. ■

**Circle 44 on card or click "PTEN e-inquiry" on VehicleServicePros.com**

# TOPDON®

## THE ALL-IN-ONE AUTO-TECH TOOL



### Phoenix Max

### ADAS Heavy-Duty Trucking Key Programming



**WWW.TOPDON.US**  
 400 Commons Way, Suite A  
 Rockaway, NJ 07866-2030



**TOPDON USA SUPPORT**  
 SCHEDULE A DEMO 833-629-4832  
 SUPPORT@TOPDON.US

©2022 TOPDON USA Inc.

**Circle 45 on card or click "PTEN e-inquiry" on VehicleServicePros.com**

SPONSORED

Circle 46 on card or click "PTEN e-inquiry" on VehicleServicePros.com

## FEATURED PRODUCT



### WIRELESS PRINTING OF REPORTS FOR BOTH PRE-SCAN AND POST-SCAN RESULTS

The newly released **Zenith-5** from **CAS** is the latest edition to the Gscan family of scan tools. Advanced coverage capabilities for domestic, foreign and light truck

applications. Wireless printing of reports for both pre-scan and post-scan results as well as extensive ADAS calibration coverage. Of special note is the outstanding coverage for Hyundai, Kia, and Genesis car lines you will find with this tool. ■



**CAS**  
508-238-5855  
oemtools.com



### FOR ELECTRIC AND HYBRID VEHICLES

The **EV Battery + Coolant Leak Detector** from **Redline Detection** is designed to test the integrity of battery enclosures in electric and hybrid vehicles. Durable and compact, the unit connects to the battery enclosure on or off the vehicle, giving audible and visual progress and precise pass/fail indication specific to that battery and vehicle type when testing is complete. Data logging and reports can be accessed remotely, and the machine is programmable for future battery configurations. ■

Circle 49 on card or click "PTEN e-inquiry" on VehicleServicePros.com

### HAS DUAL TESTING MODES

The **K-Tool International Turbo Smoke Machine**, No. KITXD600T, is designed to locate leaks fast on regular and light trucks. With a push of a button, it can be switched to turbo mode to test single, twin-turbo, and supercharged vehicles. With built-in air compressors, the unit is portable. It has dual testing modes: Smoke mode and air mode. It includes two redesigned bladder blockers and has a built-in flow meter (determines the leak amount as small as .10"), vacuum, and pressure decay gauge. ■

Circle 47 on card or click "PTEN e-inquiry" on VehicleServicePros.com



### FOR EV TECHNOLOGY AND SYSTEM DESIGNS

The **Tracer Products POE-Based EV A/C Dye Complete UV Leak Detection Kit**, No. TPOPUV20EV, is engineered for EV technology and system designs. It's compatible with R-134a and R-1234yf systems and is manufactured with specialized OEM-grade compressor oil for EVs. It also maintains system resistivity with a concentrated formula. The kit includes single-dose Mini-EZ dye cartridges, a TPOPUV OPTI-PRO UV flashlight, solid-brass swivel-type R-134a coupler, R-1234yf adapter, GLO-AWAY Plus, TP9940 glasses, and a medium blue carrying case. Individually sealed in foil packaging to protect against moisture. ■

Circle 48 on card or click "PTEN e-inquiry" on VehicleServicePros.com



### FOR ALL TRUCKS AND OFF-ROAD UTILITY VEHICLES

The **FCAR Tech F4SN HD Commercial Pad** is a compact tablet for heavy duty, super duty, medium duty, and light duty truck repairs as well as off-road equipment. The tool will scan and diagnose Class 1 to 9 engine, transmission, brake, and body control units, and offers full bidirectional functions. The scanner quickly responds and easily scans and tests the trucks variety components, resets vehicle data, and analyzes all sensors live data streams. It auto scans all the components supporting J1708, J1939, and special protocol covered by the auto OEM manufacturers. ■

Circle 50 on card or click "PTEN e-inquiry" on VehicleServicePros.com

# HARNESS THE POWER

INTRODUCING THE MOST  
INTELLIGENT YET AFFORDABLE  
DIAGNOSTIC TOOLS EVER UNLEASHED!



## OTOFIX IM1

- KEY PROGRAMMER
- DIAGNOSTICS TABLET
- SERVICE RESETS

## OTOFIX D1

- BIDIRECTIONAL FUNCTIONALITY
- DIAGNOSTICS TABLET
- SERVICE RESETS

## OTOFIX BT1

- BATTERY TESTING
- ELECTRICAL SYSTEM ANALYSIS
- DIAGNOSTICS & SERVICE RESETS

# OTOFIX™

WWW.OTOFIXTECH.US ○ @OTOFIXTOOLS



Circle 51 on card or click "PTEN e-inquiry" on VehicleServicePros.com



FOR MORE INFORMATION ON THESE PRODUCTS, CLICK ON "PTEN E-INQUIRY" at [VehicleServicePros.com](http://VehicleServicePros.com) OR CIRCLE THE NUMBER ON THE CARD.

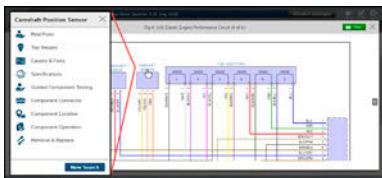

## INCLUDES ENHANCED DIAGRAM NAVIGATION

The **Mitchell 1 ProDemand Advanced Interactive Wiring Diagrams Update** further integrates diagrams with related information assets provided in ProDemand repair information software, making it faster and easier to diagnose complex electronic systems in today's modern vehicles. Users won't need to exit wiring diagrams to find crucial information like component location, pin configurations, connectors, grounds and splices, because they are now linked inside the diagrams. ■

**Circle 52 on card or click "PTEN e-inquiry" on [VehicleServicePros.com](http://VehicleServicePros.com)**

SPONSORED

**Circle 53 on card or click "PTEN e-inquiry" on [VehicleServicePros.com](http://VehicleServicePros.com)**

## FEATURED PRODUCT



## NO MORE TARGETS, MUCH MORE SPACE IN YOUR SHOP

The **TEXA Radar Camera Calibration System 3 (RCCS3)** uses a mini on-board PC and a 75" 4k monitor, both synchronized with the company's software to digitally display automatically positioned targets based on vehicle selection. Simple and easy to use, the RCCS3 clears considerable work-space in the shop and simplifies operator workflow. The RCCS3 has several features that allow the operator to perform micro-adjustments and align the unit easily and with precision ■



**TEXA USA**  
855-200-8392  
[texausa.com](http://texausa.com)



## DETECTS INVISIBLE PROBLEMS QUICKLY

The **Innova Electronics Multi-Purpose Infrared Inspection Camera**, No. 3360, uses thermal sensors to target and record temperatures, detecting invisible problems quickly. Users can turn thermal images into a photo that can be stored and viewed at a later date as well as download images to the computer to edit, share, or print. Applications include checking the radiator and hoses for hot/cold spots, inspecting brake calipers, and measuring HVAC lines and condensers. The Innova 3360 features a 2" color screen, IP54 rating, and a measuring range of -4 to 1,112 degrees F. ■

**Circle 54 on card or click "PTEN e-inquiry" on [VehicleServicePros.com](http://VehicleServicePros.com)**

SPONSORED

**Circle 55 on card or click "PTEN e-inquiry" on [VehicleServicePros.com](http://VehicleServicePros.com)**

## FEATURED PRODUCT

## ACCESS TO ALL VEHICLE SYSTEMS AND MODULES

The **CanDo CPro** is a full functionality passenger and light truck scan tool with coverage for all major North American, European, and Asian manufacturers. Complete with bidirectional controls, special test functions, and a full suite of adaptations and service resets, the CPro is also wireless to the car, intuitive to use, and easy to update. A Remote Technician function is also included at no extra charge. ■



**CanDo International Inc.**  
909 CANDO-11  
[candointl.com](http://candointl.com)



## 1,000V AC/DC VOLTAGE AND 10A AC/DC CURRENT

The **Lang Tools CAT IV Digital Multimeter**, No. 13811, is a handheld professional multimeter that can measure up to 1,000V AC/DC voltage and 10A AC/DC current. It can also measure resistance, diode, continuity, and mx-Pulse/duty cycle. The multimeter features auto ranging, data hold, and is CAT III 1000V and CAT IV 600V rated. The multimeter includes test leads, batteries, a temperature probe, and a manual. ■

**Circle 56 on card or click "PTEN e-inquiry" on [VehicleServicePros.com](http://VehicleServicePros.com)**



### PROVIDES QUICK, HIGH-ACCURACY TESTS FOR EV BATTERY PACKS

The **E-XTEQ E-VLT Leak Tester** is designed to provide quick, high-accuracy tests for EV battery packs, electric motor cavities, and gearbox housing/cooling systems. E-VLT is equipped with three different test options which include hydrogen, smoke, and snoop test. It utilizes Argos cloud-based system for job traceability, test parameters, and threshold updates. ■

**Circle 57 on card or click "PTEN e-inquiry" on VehicleServicePros.com**



### PROVIDES LIVE ACCESS TO EXTENDED VEHICLE DIAGNOSTIC DATA

The **Continental Autodiagnos Drive** is a remote vehicle data solution designed to deliver advanced diagnostic information that service providers, fleet managers, and repair facilities can use to maximize their data-driven services. The easy-to-install, plug-and-play technology provides users with live access to extended vehicle diagnostic data for all popular makes and models of passenger cars, light trucks, and commercial vehicles. Autodiagnos Drive helps customers increase productivity, reduce downtime, enhance customer service, and gain better insights into the condition of the vehicles they service or manage. The system will also help them to quickly provide vehicle owners with reliable and up-to-date information about their vehicle's health and performance parameters. ■

**Circle 59 on card or click "PTEN e-inquiry" on VehicleServicePros.com**

SPONSORED  
**Circle 58 on card or click "PTEN e-inquiry" on VehicleServicePros.com**

## FEATURED PRODUCT

### FEATURING CANFD AND DOIP ADVANCED PROTOCOLS

The Android-based **Millennium MAX** from **Launch Tech** can perform 29 advanced service functions and support CANFD and DoIP protocols, making it a professional level diagnostic tablet. Featuring a 7" touchscreen and intuitive interface, the tablet is easy to operate. It also supports full system diagnosis to read and clear trouble codes as well as offers auto detect VIN, Wi-Fi software updates, generates and shares diagnostic reports, and more. ■



**LAUNCH TECH USA**  
 CREATE • CHANGE

**Launch Tech**  
 562-463-1580  
 launchtechusa.com



### FLEXIBLE TO INSPECT HARD-TO-REACH SPACES

The **ANSED Diagnostic Solutions Hi-Res Digital Video Scope Kit with 6mm Articulation Probe**, No. DVSK-60ART, features a 6mm diameter articulation imaging probe that lets the user look back up to 180 degrees, making it ideal for any engine work. The videoscope is flexible, allowing users to monitor, capture, and inspect hard-to-reach spaces and cavities. The video monitor supports 13 languages, offers a 3.5" full view IPS LCD display, and has a solid rubber boot protector for shock resistance. The DVSK-60ART kit also contains an 8G SD mini card, USB cable for charging, user manual, and a hard-shell plastic carrying case. ■

**Circle 60 on card or click "PTEN e-inquiry" on VehicleServicePros.com**



### FEATURES EZ-SENSOR PROGRAMMING

The **ST-1 TPMS Tool** from **Schrader TPMS Solutions** features EZ-sensor programming and an ID-Sync function for matching scanned IDs to vehicle ECU IDs. The tool triggers OE sensors for all cars in North America, Europe, and Asia. It displays all sensor data (pressure, battery, temperature, ID, frequency) and indicates OE sensor and service kit part numbers. In addition, it provides TPMS ECU relearn procedures and retrieves and decodes TPMS DTC information. The TPMS tool has a 2.8" LCD screen, protective rubber sleeve, is Wi-Fi capable, and comes with a quick-connect cable and carrying case. ■

**Circle 61 on card or click "PTEN e-inquiry" on VehicleServicePros.com**



FOR MORE INFORMATION ON THESE PRODUCTS, CLICK ON "PTEN E-INQUIRY" at [VehicleServicePros.com](http://VehicleServicePros.com) OR CIRCLE THE NUMBER ON THE CARD.

SPONSORED

Circle 62 on card or click "PTEN e-inquiry" on [VehicleServicePros.com](http://VehicleServicePros.com)

## FEATURED PRODUCT



### SECURE OEM VALIDATED J2534 REPROGRAMMING

The **DG Technologies VSI NxGen** is the Vehicle Standard Interface for the next generation of vehicles and technicians. This tool gives you the most proven and OEM validated technology, all protected by CyberGuard! Providing technicians and vehicle security professionals with ECU and

key programming, ADAS calibration, and diagnostics with J2534-1/2 compliance. The VSI NxGen features CAN FD plus all other automotive protocol communication, and is built rugged for any shop environment. ■



DGTECH.COM  
**DG TECHNOLOGIES**  
Vehicle Network Solutions

**DG Technologies**

248-888-2000  
[dgtech.com](http://dgtech.com)



### OFFERS 28 NEW BRANDS AND 809 NEW MODELS

The **Cojali Jaltest Software 22.1 Update** includes 28 new brands, 809 new models, and 4,179 new systems. New troubleshooting guides (now SMART guides) of the most common error codes have been added, which are available in the module of troubleshooting guides by symptom and associated with diagnostics errors. It also includes a quick system scan and new functionalities to improve the user experience. ■

Circle 63 on card or click "PTEN e-inquiry" on [VehicleServicePros.com](http://VehicleServicePros.com)



### ENHANCED 22MY COVERAGE AND ADAS SUPPORT

The **AutoEnginuity Giotto Version 20.1** for the Windows platform includes enhanced 22MY coverage and ADAS support. Other highlights include added Ford 18MY+ actuation support (e.g., ABS and CCM calibration) and Jaguar/Land Rover DoIP system support (requires J2534 device). Additionally, Version 20.1 offers more support for BMW/MINI, GM, Open/Vauxhall, Porsche, Renault, and VAG. ■

Circle 64 on card or click "PTEN e-inquiry" on [VehicleServicePros.com](http://VehicleServicePros.com)



### PROVIDES LOCAL AND REMOTE DIAGNOSIS

The **TOPDON Phoenix Remote** is designed to provide local and remote diagnosis. It supports voice and video calls to ensure users have real-time communication options available. The scan tool provides coverage to over 200 types of cars and new energy vehicles, features a 10.1" oil-proof LCD touchscreen and contains online coding for more than nine major vehicle brands. It also supports CAN2.0, CANFD, DoIP, J2534, D-PDU, and RP1210 protocols. ■

Circle 65 on card or click "PTEN e-inquiry" on [VehicleServicePros.com](http://VehicleServicePros.com)

SPONSORED

Circle 66 on card or click "PTEN e-inquiry" on [VehicleServicePros.com](http://VehicleServicePros.com)

## FEATURED PRODUCT



### PROVIDES FOR FASTER TPMS SERVICE

Designed for use by BOTH the beginning service technician and the expert automotive service professional, the **Tech600Pro** is one of **Bartec's** latest TPMS service tool solutions. Where high tech and affordability meet, the Tech600Pro offers many advanced features that will help service many more vehicles that have TPMS. Included are more OBD-II relearns, Wi-Fi updating, VINdicatE, RITE-SYNC, inductive charging, and placard adjusting. The advanced technology of the Tech600Pro provides for faster TPMS Service, flexibility in TPMS service and use, and greater coverage of TPMS sensor solutions. The Tech600Pro is fast, accurate, easy, and wireless! ■



**Bartec USA**  
586-524-1507  
[bartecusa.com](http://bartecusa.com)

## CONTAINS WATERTIGHT GASKETS AT THE SEAMS

The **Power Probe DM500MAX Digital Multimeter** is designed for superior accuracy and measurement reliability. Built for even the harshest work environments, the tool contains watertight gaskets at the seams, a rotary switch, input terminals, and a battery cover to keep out dust, dirt, and moisture. The DM500MAX can survive falls and drops with its outer housing protector and includes a special designed LoZ (low impedance) feature to prevent false readings caused by ghost voltages. Additionally, it has a 40,000 count extra-large digital display and 40,000 records data logging capacity, and an auto-save mode that ensures new readings are automatically saved. ■

Circle 67 on card or click "PTEN e-inquiry" on VehicleServicePros.com



SPONSORED  
Circle 68 on card or click "PTEN e-inquiry" on VehicleServicePros.com

## FEATURED PRODUCT



### V3300 WORRY-FREE DIAGNOSTIC WHEEL ALIGNER

Most OEMs with ADAS equipment recommend or require the vehicle to be in proper alignment before recalibrating to ensure the sensors and vehicle are moving in the same direction. To help you get it right, the **John Bean V3300 Alignment System** has an ADAS sensor alert that will notify them when the vehicle includes ADAS features and will provide the right ADAS calibration procedure. And, the V3300 advanced notification system monitors the entire alignment procedure, automatically correcting and compensating for simple issues ensuring that every alignment is completed correctly. ■

# John Bean

**John Bean**  
800-362-4618  
johnbean.com

## REMOVE RUSTED AND OBSTRUCTED DIESEL NOx & PARTICULATE SENSORS "THE SHOCKIT™ WAY"!

### LT996D Shockit™ Socket Diesel NOx & Particulate Sensor Removal Kit

- Air hammer powered Shockit™ Sockets for removing diesel exhaust sensors
- Compact sizes for reaching sensors with restricted access
- Uses the force and vibration of an air hammer to loosen the most rusted sensors
- Includes non-turning offset 8mm radius tip LT1910P 11" Standard Shockit™ Punch
- Force and vibration of air hammer allows most sensors to be removed without damaging the threads
- Each Shockit™ Socket has 3 driving ears w/ 8mm indexed holes for delivering maximum rotational force
- Each Shockit™ socket has inverted index holes for tightening and loosening, allowing the most stubborn sensors to be worked back and forth during removal
- 22mm Shockit™ Socket removes NOx sensors on Chevy® Duramax, Dodge® Cummins, Ford® Power Stroke. Also removes most Semi Truck NOx sensors including Kenworth®, Cummins®, International®, Detroit & Volvo®
- 22mm Low Profile Shockit™ Socket for delivering maximum rotational force and minimum side loading for extremely stuck NOx sensors
- 22mm Thin Wall Deep Shockit™ Socket removes NOx sensors on Jeep® & RAM® ECO Diesel
- 24mm Shockit™ Socket removes Particulate Sensors (Soot Sensors) on Chevy® Duramax, Dodge® Cummins and Ford® Power Stroke
- 24mm Low Profile Shockit™ Socket for delivering maximum rotational force and minimum side loading for extremely stuck particulate sensors
- 30mm Shockit™ Socket removes the NOx sensor lock nuts on Jeep® and Ram® ECO Diesel
- Includes 20mm, 22mm & 27mm bottoming tap and dies for sensor and mounting hole threads
- Must be used with Shockit™ Punches for maximum performance and warranty coverage
- Additional Shockit™ Punches sold separately - LT1910PS 5.5" Short Punch, LT1910PL 22" Long Punch
- Patent #7,677,143

**AIR HAMMER  
POWERED**

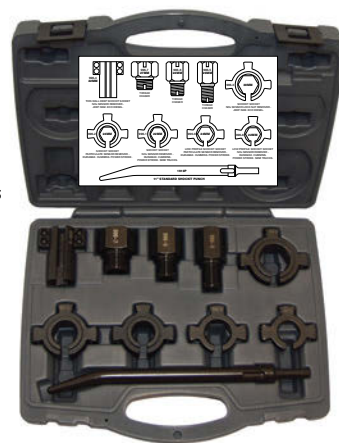

**NEW  
PRODUCT**



## EASILY REMOVE & INSTALL BENDIX/KNORR-BREMSE AIR DISC BRAKE PAD RETAINERS!

### LT891 Bendix/Knorr-Bremse Air Disc Brake Pad Retainer Tool

- The only tool made for servicing Bendix/Knorr-Bremse air disc brakes
- Provides safer and easier way to remove pad retainer
- Works with left and right side calipers
- Heat treated for strength and durability
- Designed to work with or without caliper shield
- Easy grip handle
- Patent pending



Scan to see tool work!



**NEW  
PRODUCT**



**LOCK TECHNOLOGY, INC.**  
Toll Free 800-421-7241



**Innovator of Great Ideas**

www.ltiitools.com  
ltiitools@ltiitools.com

Circle 69 on card or click "PTEN e-inquiry" on VehicleServicePros.com

SPONSORED

Circle 70 on card or click "PTEN e-inquiry" on VehicleServicePros.com

## FEATURED PRODUCT



### IDEAL FOR BRAKE, FUEL, AIR, AND HYDRAULIC LINE APPLICATIONS

AGS's innovative **Crows Feet Flare Nut Sockets** allow you to access hard-to-reach fittings where a wrench just can't reach. The 3/8" drive makes access easy with a standard ratchet and extension. The 200 degree swivel heads have hex key screws so you can adjust flexibility, and avoid the heads flopping around. Ideal for brake, fuel, air, and hydraulic line applications. Once you use these sockets, you'll wonder how you ever got along without them! Available in SAE and metric sizes. Packaged on a rail for easy storage and selection. Limited lifetime warranty. ■



**AGS Company**  
800-253-0403  
agscompany.com



### FOR USE IN MINIMAL ACCESS SPACES

The **Tekton 3/8" Drive Folding Ratchets** are designed for use in minimal access spaces, providing low leverage and high speed. The patent-pending ratchets use the company's 90-tooth ratchet mechanism in the ultra-compact 3/8" drive head. They fully extend into a small offset ratchet. In partially folded positions, the handle gets out of the way for greater access, and in the fully closed position, they are an ergonomic palm ratchet. The joint is non-locking for continuous range and stiff so that it doesn't flop around. The ratchets are available in quick-release and non-quick release models. ■

Circle 73 on card or click "PTEN e-inquiry" on VehicleServicePros.com

### CONVENIENT THUMB-OPERATED REVERSE SWITCH MECHANISM

The **Dynamic Tools 108-Tooth Ratchets** are industrial-quality ratchets designed for budget-sensitive professionals.

Featuring a 108-tooth gear with 3.5-degree arc swing, the ratchets have a nickel-plate mirror chrome finish for maximum corrosion resistance. A secure socket lock keeps sockets firmly installed until ejected via the quick-release button. A convenient thumb-operated reverse switch mechanism easily changes between tightening and loosening. The sleek, comfortable handle is user friendly, while the low-profile head provides ideal access in confined spaces. The ratchets are available in 1/4", 3/8", and 1/2" drive, or can be purchased as a set of three (No. D001309). ■

Circle 71 on card or click "PTEN e-inquiry" on VehicleServicePros.com



### A SCREWDRIVER AND PRY BAR IN ONE

The **Mayhew Tools 3-pc Demo Driver Set**, No. 40180, features a hybrid design of a screwdriver and pry bar in one, making them ideal for various lifting and prying applications, such as removing brake calipers, drum brakes, and wheel caps. The set includes three lengths: 8", 10", and 11". Each driver is comprised of Mayhew's patented two-composite, ergonomic Dominator handle, providing comfort and a secure grip. The handle's capped end allows for striking without causing damage to the handle, while simultaneously serving as a shock absorber to reduce user hand fatigue. Made in the U.S.A. ■

Circle 74 on card or click "PTEN e-inquiry" on VehicleServicePros.com

### INCLUDES DURABLE LATCHING CASE FOR STORAGE

The **Sunex Tools Simple Torque Indexing Torque Wrenches** are designed with a 16-position torque selecting mechanism that adjusts the torque and locks it into place with a simple press and slide of a button, reducing time and allowing users to go from minimum to maximum torque in less than a single rotation. Each torque wrench includes a durable case with latches for safe storage and are pre-calibrated to accuracy ±4 percent. The torque wrenches include: 1/4" Dr. 25-250 in-lbs, No. 10250; 3/8" Dr. 5-80 ft-lbs, No. 30580; and 1/2" Dr. 10-160 ft-lbs, No. 21160. ■

Circle 72 on card or click "PTEN e-inquiry" on VehicleServicePros.com





### AVAILABLE IN LONG NOSE, DIAGONAL NOSE, AND BENT NOSE STYLES

The **Century Drill & Tool Spring Loaded Pliers** are available in long nose, diagonal nose, and bent nose styles. The spring loaded design makes for easy use. The pliers are made from chrome vanadium steel for strength and durability, and feature comfort grip handles for additional grip to maximize force with less fatigue. The needle nose and bent nose pliers provide ideal control and grip in small or hard-to-reach areas, while the diagonal nose pliers are ideal for cutting wire. The long nose and diagonal nose pliers are 4-1/2" in length. The bent nose pliers are 5" in length. ■

Circle 75 on card or click "PTEN e-inquiry" on VehicleServicePros.com



### INTERCHANGEABLE KEYS FOR VARIOUS APPLICATIONS

The **GEARWRENCH 33-pc Ratcheting T-Handle Hex Key Set**, No. 83518, features interchangeable keys for a wide range of uses and applications. The keys are made with alloy steel for maximum strength and to resist rotational distortion. The chamfered edges on both ends help guide the key into the fastener smoothly and quickly. The ratcheting handle increases speed when tightening and loosening fasteners, and its handle provides a comfort dual material grip to allow for added torque and non-slip use. The set includes a blow molded case for storage and organization. The set meets or exceeds ASME standards. ■

Circle 76 on card or click "PTEN e-inquiry" on VehicleServicePros.com



### ENHANCED DESIGN FOR SLIMMER PROFILE

The **Cementex Updated Double-Insulated Wrenches** now feature a continuous outer layer of orange insulation to provide a smooth transition between the dual-layer and single-layer portions of each tool. The enhanced design enables the work end of the open-end, box-end, and geared wrenches to be slimmer. According to the company, the insulation is guaranteed to pass a 10,000 VAC proof test in accordance with applicable U.S. and international standards. ■

Circle 77 on card or click "PTEN e-inquiry" on VehicleServicePros.com

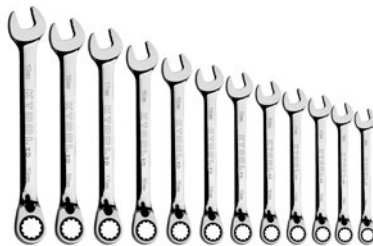

### CAN REMOVE AND TIGHTEN NUTS AND FASTENERS

The **K-Tool International 12-pc Metric 120-Tooth Reversible Combination Wrench Set** is a set of high-quality, non-slip, open-end wrenches that can remove and tighten nuts and fasteners. Designed with a patented spherical box-end, the wrenches can work for different fastener types. Featuring a 3-degree swing movement, the wrenches work great in tight areas and allow for fast and easy ratcheting direction changes with the reversing lever. The 15-degree head offset provides knuckle clearance and has an innovative design that keeps the professional technician in mind. ■

Circle 78 on card or click "PTEN e-inquiry" on VehicleServicePros.com



THE INDUSTRY LEADER

ONE KIT  
20 ENGINES  
\$300 OFF

## PowerTech Set



PMXPWT220PRO

### EXHAUST MANIFOLD BOLT REPAIR KIT

- FORD Gas: 4.2L V6, 4.6/5.4L V8, & 6.8L V10
- FORD DIESEL: 6.0L, 6.4L
- DODGE 5.7L & 6.1L
- GM LS 1999-2022: 4.8L, 5.3L, 5.7L, 6.0L, 6.2L V8

CALL PROMAXX® TOOL,  
WE LOVE TALKING TO  
TECHNICIANS!

724-941-0941



[promaxxtool.com](http://promaxxtool.com)

Circle 79 on card, or click "PTEN e-inquiry" on VehicleServicePros.com

SPONSORED

Circle 80 on card or click "PTEN e-inquiry" on VehicleServicePros.com

## FEATURED PRODUCT



### EASILY REMOVES BROKEN TAPS AND SAVES THE THREADS

Remove broken taps without drilling, lasers, scrapped parts, or repair inserts – and save the threads! The **Walton Tap Extractor's** hardened steel fingers fit in the flutes of a broken tap to back it out simply and safely. Available in every tap size – both inch and metric – as handy sets or individual pieces. Tap Extensions are also available to extend the reach of regular-length taps for deep holes and awkward locations. Proudly made in the USA. ■

**WALTON**  
COMPANY



**Walton Company**  
860-523-5231  
walmartools.com

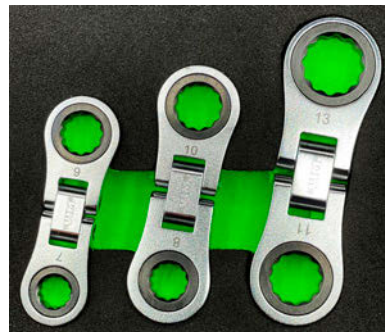

### PROVIDES 5 DEGREES OF SWING ARC

The **VIM Tools Nano Flex Ratcheting Wrench Set**, No. FPRW100, features a compact size for fast and easy hand movements in confined spaces. Its double-joint design meets and exceeds ANSI torque specifications and its 72-tooth ratcheting mechanism allows for a small swing arc of 5 degrees. The ratcheting wrench set is ideal for use in tight spaces, including dashboards, door panels, engine bays, and many other areas with limited access. ■

Circle 81 on card or click "PTEN e-inquiry" on VehicleServicePros.com



### MICROFIBER HANDLE COATING

The **Matco Tools 10-pc Top Torque II Screwdriver Set**, No. SSPCB10C, features both Phillips and slotted sizes. Lightweight and rugged, the blades are built with high-alloy German steel and have black phosphate on the tip. The blades are molded into the handle and have a wide forged butterfly in the end so that the blade will not turn in the handle, pound through, or pull out. The three-sided ergonomic handle allows for optimal turning power and torque. The screwdrivers also feature a microfiber handle coating to provide an ideal grip even when hands are slippery with oil, grease, or perspiration. ■

Circle 82 on card or click "PTEN e-inquiry" on VehicleServicePros.com



### INCLUDES SIX LOCKING PLIERS AND CLAMPS

The **Malco Products Eagle Grip Locking Tools** are forged from premium American steel to deliver a strong and reliable performance. Made in the U.S.A., the tools were designed to meet the rigorous demands of professional users. The line currently consists of six locking pliers and clamps for use in sheet metal, automotive, welding, and agriculture applications. The locking pliers include 7" and 10" straight jaw locking pliers and 7" and 10" curved jaw locking pliers with wire cutter. The clamps include 11" locking C-clamps and 11" locking C-clamps with swivel pads. ■

Circle 83 on card or click "PTEN e-inquiry" on VehicleServicePros.com



### BLACK OXIDE FINISH FOR CORROSION RESISTANCE

The **Lang Tools 4-pc Gasket Scraper Set**, No. 855-4ST, includes a 1/2" face, a 1" face offset, a 1" face pull, and a 1" face stubby gasket scraper. Each tool is drop forged from high carbon steel and has a black oxide finish for corrosion resistance. Each bit extends the entire length of hand to the strike plate. The strike protection hard-capped handles are ergonomically designed for comfort and durability and provide a secure grip. The blade face and scraping ends are precision ground. The gasket scrapers are made in the U.S.A. ■

Circle 84 on card or click "PTEN e-inquiry" on VehicleServicePros.com



FOR MORE INFORMATION ON THESE PRODUCTS,  
CLICK ON "PTEN E-INQUIRY"  
at [VehicleServicePros.com](http://VehicleServicePros.com)  
OR CIRCLE THE NUMBER ON THE CARD.



### AVAILABLE IN TWO SIZES AND WITH AN OPTIONAL CUTTER

The **Snap-on Flat Jaw Locking Pliers** provide ideal fastening power with its patent-pending Power Ring that increases thread strength and delivers a clamping force up to 5,000 lbs. The locking pliers feature a pinned and brazed upper jaw to ensure a bond between the upper jaw and the pliers body. They also have an oversized adjustment screw with a wide head that provides a comfortable gripping surface, making adjustments easier on hands. The smooth and polished trigger allows for easy release. The locking pliers have a bright nickel finish for a classic look and come in two sizes (7" and 10") and with an optional cutter. Made in the U.S.A. ■

Circle 85 on card or click "PTEN e-inquiry" on [VehicleServicePros.com](http://VehicleServicePros.com)



### IDEAL FOR EXHAUST WORK, BODY WORK, AND DASHBOARDS

The **EZRED 8" S-Shaped Quarter Stick**, No. 4SS8, features a compact design to allow easy access inside tight corners. The tool is forged from chrome vanadium steel, and is ideal for exhaust work, body work, dashboards, motorcycles, inside fan cowls, and other hard-to-reach areas. With a 1/4" square socket and magnetic bit drive, the tool works for most general-purpose fastener-driving, and requires only 5 degrees to move fasteners. ■

Circle 87 on card or click "PTEN e-inquiry" on [VehicleServicePros.com](http://VehicleServicePros.com)

SPONSORED  
Circle 86 on card or click "PTEN e-inquiry" on [VehicleServicePros.com](http://VehicleServicePros.com)

## FEATURED PRODUCT



### ALLOWS ACCESS IN TIGHT AREAS FROM ANY ANGLE

NEW! The **Cornwell Tools 120 Tooth Flex Head Ratchet**, No. JRF120LHB, features a 120-tooth ratcheting design that provides a 3 degree handle swing. Its 180-degree, seven-position flex head allows access in tight areas from any angle and its thin head design enables for close clearance applications. High polished, chrome plated finish provides corrosion protection. Drive: 3/8". Overall length: 12-3/8". Head thickness: 19/32". Head width: 1-3/8". ■



**CORNWELL**  
QUALITY TOOLS

**Cornwell Quality Tools**  
330-336-3506  
[cornwelltools.com](http://cornwelltools.com)

**Forney 90** YEARS STRONG!  
SINCE 1932



ALL YOUR WELDING, ABRASIVE, SHOP TOOL & SAFETY NEEDS SINCE 1932

1-800-521-6038 • [forneyind.com](http://forneyind.com) •

Circle 88 on card or click "PTEN e-inquiry" on [VehicleServicePros.com](http://VehicleServicePros.com)

SPONSORED

Circle 89 on card or click "PTEN e-inquiry" on VehicleServicePros.com

## FEATURED PRODUCT

### USES THE FORCE AND VIBRATION OF AN AIR HAMMER

Removing rusted and obstructed diesel NOx and particulate sensors has become an expensive and time consuming problem. **Lock Technology's Shockit Socket Diesel NOx and Particulate Sensor Removal Kit**, No. LT996D, solves this by using the force and vibration of an air hammer to loosen the most rusted sensors without damaging the threads and the compact sizes give access to the most difficult to reach sensors. Each Shockit Socket has three driving ears with 8mm inverted index holes for tightening and loosening, allowing for the most stubborn sensors to be worked back and forth during removal. ■



**Lock Technology**  
800-421-7241  
ltools.com



### OVER 100 STORAGE COMPARTMENTS

The **Wiha Tools 93-pc XXL3 PRO Tool Set** comes in the XXL3 Rolling Tool Case. The tool case is made from heavy duty construction, has all-terrain wheels, a 42" extendable handle, fold-out legs, and a gas-strut-propper lid. Tools in the set include 5-pc PicoFinish Precision Screwdriver set, SoftFinish Slotted Screwdriver 6.5mm, SoftFinish Square Screwdriver #2, SoftFinish X Heavy Duty Slotted 8mm, SoftFinish X Heavy Duty Slotted 12mm, SoftFinish X Heavy Duty Philips #2, 14inOne SoftFinish Stubby Multi-Bit Driver, SoftFinish 11inOne Multi-Driver, Classic Grip Long Nose Pliers 8", Classic Grip BiCut SuperCut 8", Classic Grip Auto Pliers 10", Classic Grip End Cutting Nippers 8", 9-pc MagicRing Ball End Hex L-Key Set (metric), 13-pc MagicRing Ball End Hex L-Key Set (inch), 6-pc Color Coded Magnetic Nut Setter Set, and 35-pc 1/4" Ratchet and Bit Set. ■

Circle 91 on card or click "PTEN e-inquiry" on VehicleServicePros.com



### REMOVES U-JOINT SNAP RINGS

The **Cal-Van Tools Straight Snap Ring Pliers**, No. 49, are designed for removing U-joint snap rings, interior clips, and body panel fasteners. The pliers are also available in 75 degree offset, No. 48, for use in confined areas. ■

Circle 92 on card or click "PTEN e-inquiry" on VehicleServicePros.com



Over 50 years of OEM quality at aftermarket prices!



Scan for our catalog



Cat. No. 89360  
5 Pc. Body Punch Set  
• 5 profiles for forming hard to reach areas  
• Polished and hardened surfaces  
• 12" OAL



Cat. No. 18840  
Battery Terminal Crimper  
• 8 - 4/0 AWG  
• Uninsulated terminals  
• 26" OAL



Cat. No. 18700  
Master Terminal Service Kit  
• Crimps Deutsch, Weather Pack, Metri-Pack, and many other open and closed barrel terminals  
• Includes disconnects

www.toolaid.com

Circle 90 on card or click "PTEN e-inquiry" on VehicleServicePros.com



### INCLUDES 86 INDIVIDUAL TWEEZERS

The **KNIPEX Line of Tweezers** includes 86 individual tweezers and five sets. The four main categories of tweezers include positioning, stripping, cutting, and gripping. Constructed

with a variety of materials, such as titanium, premium stainless steel, stainless steel, steel, and plastic, these tweezers offer corrosion-resistance, anti-magnetic, and chemical-resistant properties. Other notable features include tweezers that are rated up to 1000V, plastic dip insulated handles, and thumb guards to prevent slipping. The line includes electrostatic discharged tweezers, some with replaceable tips, that help prevent transfer of electricity when working with sensitive electronic components. ■

**Circle 93 on card or click "PTEN e-inquiry" on VehicleServicePros.com**

### INCLUDES SIZES 13MM TO 19MM

The **Mueller-Kueps Line Sensor Wrench Kit**, No. 457 720, is a dropforged kit suited for exhaust sensors, brake lines, power steering lines, NOx, exhaust temperature, oxygen sensors, and more. The kit includes sizes 13mm to 19mm and features a stepped flange for easier access to lines. One side of the wrench



can be used for maximum torque while the side with the flex head can be used for narrow spaces. Both ends have an inner hex to avoid slipping as easily. They also have an extra lip to provide additional strength. ■

**Circle 94 on card or click "PTEN e-inquiry" on VehicleServicePros.com**

### THICK ERGONOMICALLY DESIGNED HANDLES FOR SECURE GRIP

The **Performance Tool 3-pc Pry Bar Set with Strike Cap**, No. W2023, includes 12", 17", and 24" sizes. The tools feature thick ergonomically designed handles for comfort and a secure grip, and are made of high carbon steel for strength and durability. The capped ends allow users to strike with a hammer without damaging the handle. Curved blade ends and long shafts provide ideal delivery of prying power. The bars are fully hardened and tempered and have a black powder coating to prevent rust. ■

**Circle 95 on card or click "PTEN e-inquiry" on VehicleServicePros.com**



# DOES YOUR METER MEASURE UP?



**13811**  
CAT IV GENERAL PURPOSE & HYBRID MULTIMETER



**13803**  
AUTOMOTIVE DIGITAL MULTIMETER



**13809**  
BASIC CAT III DIGITAL MULTIMETER

**LANG**  
TOOLS  
Professional Tools For 4 Generations

**WWW.LANGTOOLS.COM**

**Circle 96 on card or click "PTEN e-inquiry" on VehicleServicePros.com**

SPONSORED

Circle 97 on card or click "PTEN e-inquiry" on VehicleServicePros.com

## FEATURED PRODUCT



### AUTOMATICALLY ADJUSTS TO FIT BOLTS OF 3/8" TO 11/16"

The **NES 5 Tight Space Thread Restorer** is the ideal tool to repair damaged external threads in restricted areas such as the engine and especially for wheel studs. It's a real time-saver instead of spending time and money to replace damaged stud bolts. Capacity: 3/8"-11/16" (10-18mm) and its two cutters adapt to any pitch, coarse or fine - a true universal tool and a must-have for all tire shops and technicians. The tool compliments the full range of NES external and internal thread repair tools.

"When your threads are a mess, reach for NES". ■



**Anglo American Tools**

856-784-8600

[angloamericantools.com](http://angloamericantools.com)



### INCLUDES 11 MAGNETIC TIP BITS

The **Vessel Low-Profile Flat Plate Ratchet Screwdriver Sets**, Nos. TX-76U and TX-79U, are ideal for use in very limited spaces. Both sets include a ratchet, a 2-pc internal bit storage, and an 8-pc external storage. The ratchet measures 4" in length and has a total height of 0.7" after attaching a 0.7" long insert bit (13/32" height without bit insertion). The TX-76U has a straight ratchet whereas the TX-79U offers a 15 degree angle. The magnetic tip bits include: slotted 4mm and 6mm; Phillips PH1, PH2, and PH3; Torx T20, T25, T27, and T30; and Metric hex: 3mm, 4mm, and 5mm. ■

Circle 98 on card or click "PTEN e-inquiry" on VehicleServicePros.com



### PREVENTS JOINT FROM FALLING TO ONE SIDE

The **Titan Professional Tools 1/2" Dr.10" Auto Flex Extension**, No. 62110, features an auto-flex, spring-loaded design which prevents the joint from falling to one side. Additionally, the auto flex design allows for one hand operation. The tool is constructed of chrome-vanadium steel, has an overall length of 10", and weighs 0.75 lbs. The Auto Flex Extension is also available in 1/4" Dr. 6" (No. 66109) and 3/8" Dr. 8" (No. 68108). ■

Circle 99 on card or click "PTEN e-inquiry" on VehicleServicePros.com



### ACCOMMODATES AWG20 TO AWG12

The **OTC Angled Wire Stripping Tool**, No. 5950D, is designed to put the stripping dies on the angled tip, above the pivot point, to give users the right angle to neatly strip or cut wires in tough-to-reach places. The proprietary design allows for a better view for those tasks done in tight spaces. It's ideal for wiring service under dash, inside panels, and in the engine compartment. The tool accommodates AWG20 to AWG12. ■

Circle 100 on card or click "PTEN e-inquiry" on VehicleServicePros.com



### WORKS IN HARD-TO-REACH PLACES

The **Lisle Corporation 1-1/2" Stainless Straight and Offset Blade Scrapers**, Nos. 83640 and 83650, feature a rigid stainless steel blade that extends through the handle to the metal capped end for strength and durability. With a soft grip handle and hammer end, the scrapers are ideal for removing windshield stops and rusted on disc brake caliper brackets. They also remove carbon from turbo vanes, urethane, gaskets, and many other applications. The offset blade design works in hard-to-reach places. ■

Circle 102 on card or click "PTEN e-inquiry" on VehicleServicePros.com

### INCLUDES DEEP AND SHORT METRIC SOCKETS

The **CTA Manufacturing 69-pc Euro Metric Tool Set - 3/8" Drive**, No. 10100, includes 14-pc six-point deep metric sockets, 19-pc six-point short metric sockets, 7-pc metric hex bit sockets, 12-pc E-Torx sockets, 12-pc T-Torx sockets, one 3/8" drive ratchet, two extensions (6" and 10"), one U-joint, and one 1/2" to 3/8" drive adapter with breaker bar hole. ■

Circle 101 on card or click "PTEN e-inquiry" on VehicleServicePros.com





FOR MORE INFORMATION ON THESE PRODUCTS,  
CLICK ON "PTEN E-INQUIRY"  
at [VehicleServicePros.com](http://VehicleServicePros.com)  
OR CIRCLE THE NUMBER ON THE CARD.



### HARD STAMPED MARKINGS FOR CLEAR IDENTIFICATION

The **DeWalt 85-pc 3/8" and 1/2" Mechanic Tool Set with ToughSystem 2.0 Tray** is designed to help users tackle a wide range of jobs in the shop. The sockets, tools, and attachments are included inside a ToughSystem 2.0 Shallow Tool Tray with molded inserts and compatible lids for simplified organization. The set also includes a flexible 72-tooth ratchet that maneuvers easily even in confined spaces thanks to its 5 degree arc swing. The set pieces each feature a full-polish chrome finish for long-lasting, corrosion-resistant performance. ■

Circle 103 on card or click "PTEN e-inquiry" on [VehicleServicePros.com](http://VehicleServicePros.com)

SPONSORED

Circle 104 on card or click "PTEN e-inquiry" on [VehicleServicePros.com](http://VehicleServicePros.com)

## FEATURED PRODUCT

### PROVIDES NEARLY 18 TONS OF FORCE

The **Schley Products High Pressure Ball Joint Press**, No. 18100, is designed to remove and reinstall most press-in type ball joints equipped on late model Ford and Dodge full-size pickup trucks, 4500/5500 series GM trucks, and other vehicles equipped with steering knuckles and ball joints.

The 18100 utilizes patented technology that incorporates tenacious 2:1 pivoting action with durable forged alloy steel construction, which increases the effective pressing force of the tool and lowers the operating weight down to approximately 25 lbs. It provides nearly 18 tons of force and plenty of clearance between the frame, pivot link, and cups, enabling the tech to remove and install ball joints while the vehicle is on a lift or alignment rack. ■



**TOOLS**

SCHLEY PRODUCTS INC.

SP Tools/Schley Products Inc.

714-693-7666  
[sptool.com](http://sptool.com)



### 15-DEGREE OFFSET HEAD

The **Platinum Tech 7-pc SAE Flare Nut Wrench Set**, No. PLT-99700, is ideal for use on hex nuts made of softer materials. Its flare nut design allows for a better grip

without slipping, and the opening in the head gives greater access to fittings used on tubing. The wrenches have a 15-degree offset head and are made from chrome vanadium steel for strength and durability. They also have a full polish chrome finish for corrosion resistance, and meet or exceed ANSI standards. ■

Circle 105 on card or click "PTEN e-inquiry" on [VehicleServicePros.com](http://VehicleServicePros.com)

### MEETS ASME B107.300 SPECIFICATIONS WITH AN ACCURACY OF +/- 4 PERCENT

The **Mac Tools 1/2" Drive 50-250 ft-lb Direct Torque Wrench**, No. TWV250DR, meets ASME B107.300 specifications with an accuracy of +/- 4 percent. The torque wrench features a direct read scale for easy read-out. Using a magnifier and number scale help reduce errors and improve efficiency when setting a required torque. The product also features a sealed body rated at IP54 to help eliminate dust ingress for durability and is offered in a 1/2" drive 30-150 ft-lb and 3/8" drive 7-40 ft-lb version. ■

Circle 106 on card or click "PTEN e-inquiry" on [VehicleServicePros.com](http://VehicleServicePros.com)



**Ken-Tool**  
WHEREVER TIRES ARE CHANGED™

**Rust Rhino**  
HUB CLEANING TOOL

PN 30267

Designed to quickly clean the lug stud and mating surfaces of truck wheel components, ensuring proper torque and clamping force is achieved.

- Attach to any power driven tool
- Capable of accepting a 1/2" square drive.
- Maximum Rotation: 4000 rpm

PATENT PENDING

Kit includes one additional Rust Rhino Cleaning Head (A) and Inner Cleaning Brush Attachment (B). Replacements available.

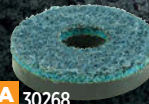

A 30268



B 30269



1-888-536-8665

[www.KENTOOL.com](http://www.KENTOOL.com)

768 E. North Street • P.O. Box 9320, Akron, Ohio 44305 • [sales@kentool.com](mailto:sales@kentool.com)

Circle 107 on card or click "PTEN e-inquiry" on [VehicleServicePros.com](http://VehicleServicePros.com)

SPONSORED

Circle 108 on card or click "PTEN e-inquiry" on VehicleServicePros.com

FEATURED PRODUCT



**STORM PROOF, PORTABLE, AND RECHARGEABLE**

With its sleek silhouette and integrated pocket clip, the **Coast PM50R Rechargeable Work Light** is both versatile and practical as an everyday carry. The flashlight is built to IP54 storm-proof specifications and features multiple lighting and positioning options. Use the 105 lm BULLS-EYE Spot Beam for longer-distance tasks and the two-mode 185 lm C.O.B. side area light for up-close work. A magnetic tail cap creates a handsfree mounting option, and the ruler etched into the handle comes in handy for quick measurements. A full charge powers the flashlight for up to 9 hours. Users can monitor the battery charge indicator for real-time power status. ■



**Coast Products**  
503-234-4545  
coastportland.com



**MULTI-PURPOSE AND POWDER FREE**

**Glove King Premium Black Nitrile Gloves** from **PermaSafe** are powder free, latex free, and non-sterile. The nitrile gloves are extra thick, measuring 6 mil, ideal for heavy duty industrial and automotive use. Additionally, they are designed to provide a flexible fit, are chemical resistant, and offer biological protection. Packaged 100 per box and 10 boxes per case, the gloves are available in sizes from medium to XL. They have a three year shelf life. ■

Circle 109 on card or click "PTEN e-inquiry" on VehicleServicePros.com



**HEAVY DUTY ZIP OFFERS EASY ON/OFF CONVENIENCE**

The **Blundstone Brown Crazy Horse Work Boots Series Side Zip Work Boots**, No. 983, provides ideal under-foot protection, with a lightweight, penetration-resistant insole. The lace up design provides ankle protection while the heavy-duty zip offers easy on, easy off convenience. The work boots also feature a moulded TPU bump cap for added leather protection, impact-resistant steel toe cap, padded tongue and collar, thermal regulating bamboo lining, and a removeable arch footbed. The footbed is anti-bacterial, washable, and offers XRD extreme impact protection. Additionally, the boots are electrical hazard resistant. ■

Circle 110 on card or click "PTEN e-inquiry" on VehicleServicePros.com

**OFFERS FULL SIDE PROTECTION**

The **Brass Knuckle Midnight Safety Glasses**, No. BKDST-1050AFP, features 99.99 percent UV protection and a soft yet tough EVA foam dust filter that fills the gap between the glasses and the face to seal in eyes and keep dust out. When opened to wear, side shield earpieces meet extended lenses at a tight, precision-cut seam for true wraparound protection. The safety glasses have a soft nose bridge and co-injected temples for comfortable cushion and full side protection. ■

Circle 111 on card or click "PTEN e-inquiry" on VehicleServicePros.com



**BREATHABLE MESH KEEPS FEET COOL**

The **Keen Utility Birmingham Work Shoe** features a breathable engineered mesh upper to keep the feet cool and supported when conditions heat up. Notable highlights include a lightweight, compression-resisting KEEN.ReGEN midsole that returns 50 percent more energy than standard EVA foam, and a KonnectFit heel-capture system that provides a secure, locked-in feel, the company says. Additionally, the shoe includes asymmetrical carbon fiber toes and an oil and slip-resistant, non-marking rubber outsole. The Birmingham is available in two colorways for men. ■

Circle 112 on card or click "PTEN e-inquiry" on VehicleServicePros.com





FOR MORE INFORMATION ON THESE PRODUCTS,  
CLICK ON "PTEN E-INQUIRY"  
at [VehicleServicePros.com](http://VehicleServicePros.com)  
OR CIRCLE THE NUMBER ON THE CARD.

## NATURAL RUBBER LATEX FOR DURABILITY

The **Ansell ActivArm Electrical Insulating Gloves Class 00** offer suitable hand protection against electrical discharge up to 500V AC/750V DC. Made from natural rubber latex using a proprietary environmentally friendly dipping process, the gloves provide ideal flexibility and dexterity to the end-user for prolonged periods of use. The gloves ergonomic hand-at-rest shape and non-splayed fingers reduce hand fatigue, and the flared cuff allows room for clothing. The design also features a smooth-finish for easy donning and doffing. Gloves meet all applicable NFPA, OSHA, and CSA standards. ■

Circle 113 on card or click "PTEN e-inquiry" on [VehicleServicePros.com](http://VehicleServicePros.com)

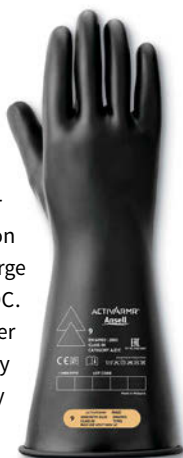

## CYCLONIC VENTING FOR FOG REDUCTION

The **Thraxus Max Safety Eyewear from Radians** is designed with straighter lines and edgier surface junctions. Notable features include an enhanced field of vision for increased protective coverage, cyclonic venting for fog reduction, floating nose loop and adjustable nose pads for a better fit, and paddle-shaped temples to distribute weight and pressure for all-day comfort. The Thraxus Max provide 99.9 percent UV protection and are offered in several lens colors (clear, smoke, and amber), frame options (crystal, gunmetal, and digital camo), and IQuity anti-fog lenses are also available. ■

Circle 114 on card or click "PTEN e-inquiry" on [VehicleServicePros.com](http://VehicleServicePros.com)



## FLEXIBLE HEAD BENDS UP TO 180 DEGREES

The **STKR FLEXIT Pocket Light** performs as a traditional flashlight, yet features a head that bends up to 180 degrees, allowing the user to point the light exactly where it's needed. It offers handsfree lighting by being able to stand upright, hang from its built-in hook, attach to metal surfaces via built-in magnet, or clip onto a pocket or belt. The aluminum LED housing contains a center CREE spotlight and a ring of floodlights for wide-angle lighting. The LEDs can be used independently or at the same time. The pocket light is rechargeable and includes a charging cable. Available in 400 lm or 650 lm. ■

Circle 115 on card or click "PTEN e-inquiry" on [VehicleServicePros.com](http://VehicleServicePros.com)



## HAS A CONVENIENT MAGNETIC CHARGING SYSTEM

The **Ledlenser H15R Core Headlamp** combines ideal light output and focus-ability, the company says. The headlamp features long runtimes with its removable battery and convenient magnetic charging system. The wheel switch on the lamp head makes for easy operation and brightness control, while the lamp head itself rotates seamlessly, so users can quickly direct light to where it's needed most. The H15R Core Headlamp is also protected from dust and water. ■

Circle 116 on card or click "PTEN e-inquiry" on [VehicleServicePros.com](http://VehicleServicePros.com)



## FEATURES SKIN SENSITIVE TECHNOLOGY

The **Adenna Optify Nitrile Disposable Gloves** are 9 mil thick, blue, extended cuff disposable gloves that feature skin sensitive technology, which means all sulfurs and chemicals that users may be allergic to in gloves are removed. The gloves are resistant to chemicals, and they have been tested to be resistant to Chemo and Fentanyl, the company says. With a 12" extended cuff, more of the users' wrist and forearm are protected during dirty jobs. The gloves come 50 per box, 10 boxes per case. ■

Circle 117 on card or click "PTEN e-inquiry" on [VehicleServicePros.com](http://VehicleServicePros.com)

## OFFERS SEVEN BRIGHTNESS LEVELS

The **Fenix Lightning LD22 V2.0 Flashlight** is a multi-use flashlight with a slim body design. The AA battery-powered flashlight emits up to 800 lm, has a maximum runtime of 220 hours, offers seven brightness levels, and includes a rechargeable Li-ion battery pack. Made of durable A6061-T6 aluminum, the LD22 V2.0 is impact resistant and waterproof underwater to 2m. It also has a detachable two-position body clip for varying conditions. ■

Circle 118 on card or click "PTEN e-inquiry" on [VehicleServicePros.com](http://VehicleServicePros.com)





SPONSORED

Circle 119 on card or click "PTEN e-inquiry" on VehicleServicePros.com

## FEATURED PRODUCT



### UPGRADE YOUR TOOL KIT WITH EASIER ACCESS TO EVEN THE TIGHTEST SPOTS

It's time to upgrade your tool kit. The **AIRCAT 115 Degree Angle Die Grinder** reaches tight or difficult spots that most grinders can't get to. The compact size increases its flexibility. With .6hp and speeds up to 18,000 rpm, this grinder is ready for tough full throttle applications. The spindle lock makes accessory change a snap, while the ergonomic composite design gives the user added comfort. Perfect for the weekend warrior to the professional. ■



**AIRCAT by Florida Pneumatic**  
561-744-9500  
aircat.com



### TOOL-FREE GUARD ADJUSTMENTS

The **Milwaukee Tool M18 FUEL 4-1/2" - 5" Variable Speed Grinders** generate 11A corded power and feature five speed settings between 3,500 rpm and 8,500 rpm, giving users ideal control by allowing them to slow down or speed up the accessory during grinding and cutting applications. The grinders feature a **RAPIDSTOP** brake for enhanced user safety, stopping most wheels in less than two seconds. The grinders are available with either a paddle switch (No. 2888-20) for increased comfort and ease-of-use when operating in various positions, or a slide switch (No. 2889-20) to reduce user fatigue. Additionally, the grinders offer tool-free guard adjustments to provide fast guard installations and adjustments. ■

Circle 121 on card or click "PTEN e-inquiry" on VehicleServicePros.com



### ALL-IN-ONE WATER AND BLOW-GUN TOOL

The **Milton Industries Hydro and Air Power Wand**, No. 171NF01, is an all-in-one water and blow-gun tool designed for cleaning hard-to-reach areas, including radiators and filters on car, truck, agricultural, and construction vehicles and equipment. The unit has air flow of 28.5 SCFM and water flow of 2.8 gpm to a maximum of 125 psi. The included adapter is at the heart of the flexibility by easily allowing the user to switch between water and compressed air. The Hydro and Air Power Wand utilizes a comfortable ergonomic handle grip with an easy-to-use four-finger trigger. Connectors include 1/4" NPT air connector and 3/4" GHT water connector for a standard garden hose. ■

Circle 120 on card or click "PTEN e-inquiry" on VehicleServicePros.com



### OFFERS QUICK AND EASY CHISEL CHANGES

The **Air Hammer**, No. SP-1410, from **SP Air** uses a hard steel cylinder and offers a free speed of 3,000 rpm. It features a quick change coil spring retainer for fast and easy chisel changes. Simply attach each chisel to remove rust from mufflers and pipes, cut body panels, and to peel off spot welds. The air hammer has a 0.4" shank size, measures 8.5" in overall length, weighs 3.6 lbs, and has a sound level of 96 dB. Also available in a kit (No. SP-1410K) that includes a sheet metal chisel, flat chisel, tapered punch chisel, and a spot welder chisel. ■

Circle 123 on card or click "PTEN e-inquiry" on VehicleServicePros.com



### DELIVERS UP TO 70 FT-LBS OF TORQUE

The **DeWalt ATOMIC Compact Series 20V Max Cordless 3/8" and 1/4" Ratchets**, Nos. DCF513B and DCF512B, deliver up to 70 ft-lbs of maximum torque. The ratchets feature a variable speed trigger to help users optimize speed based on the application at hand, and a glass-filled nylon housing to help combat damage caused by oil spills and solvents. With an integrated LED and compact build, the ratchets keep the workspace well-lit and enable access to difficult-to-reach fasteners. Battery and charger not included. ■

Circle 122 on card or click "PTEN e-inquiry" on VehicleServicePros.com

# 2022 TRAINING EVENT

**MOTOR AGE**  
TRAINING

**PTEN**  
PROFESSIONAL TOOL & EQUIPMENT NEWS

**MOTOR AGE**

**ABRN**  
AUTO BODY REPAIR NETWORK

**VEHICLESERVICEPROS**.COM

OCT. 15, 2022 - EMBASSY SUITES - ROSEMONT, ILLINOIS

# ACCELERATE

A MOTOR AGE TRAINING EVENT

## 2022 TRAINERS



### SCOTT BROWN

Session: ENGINE CONTROLLER CALIBRATIONS:  
Developing New Perspectives for Drivability Technicians



### BRANDON STECKLER

Session: SCAN TOOL ANALYSIS 101:  
Gaining Diagnostic Direction From The Driver's Seat



### PETE MEIER

Session: ELECTRICAL CHALLENGES:  
Three Steps to Successful Electrical Troubleshooting



### G. JERRY TRUGLIA

Session: HYBRIDS & EVS: Understanding  
and Diagnosing Hybrid / Electric Vehicles

REGISTER TODAY AT [WWW.ACCELERATE-CONFERENCE.COM](http://WWW.ACCELERATE-CONFERENCE.COM)

SPONSORED BY

**AUTEL**

AutoLeap

**Milwaukee**

SPONSORED

Circle 123 on card or click "PTEN e-inquiry" on VehicleServicePros.com

## FEATURED PRODUCT

### HAS AN ONBOARD AIR PRESSURE GAUGE

The **Ingersoll Rand 3/4" Impact Wrench**, No. 2146Q1MAX, is the first pneumatic impact wrench with an innovative visual air gauge that indicates whether it is operating at, below, or above the tool's maximum rated air pressure of 90 psi. The new onboard air pressure gauge uses three different colors – yellow, green, and red – to indicate how much air pressure the tool is receiving. The 2146Q1MAX empowers the operator with unprecedented control and efficiency. ■



**Ingersoll Rand**  
800-483-4981  
ingersollrand.com



### LASER ETCHED FOR EASY IDENTIFICATION

The **Titan Professional Tools 17-pc Impact Adapter Set**, No. 81483, is heavy duty impact grade and made of heat-treated chrome-molybdenum. They're coated in corrosion resistant black phosphate and are laser etched for easy identification. The components also feature quick change spring-loaded detent balls to ensure a tight, secure fit. The set includes 1/4", 3/8", and 1/2" universal joints; 1/4", 3/8", and 1/2" wobble extension bars in various lengths; and 1/4", 3/8", and 1/2" adapters. The set comes packed in a convenient organizer tray for storage. ■

Circle 124 on card or click "PTEN e-inquiry" on VehicleServicePros.com

### MOTOR DELIVERS 5,500 BPM



The **Mighty Seven Compact Needle Scaler**, No. SN-1288,

features a high-performance motor that delivers 5,500 bpm. It has a 1-1/4" stroke length and an overall weight of 2.8 lbs. Its compact design allows for easy access to confined spaces when removing surface dust, rust, paint, and weld slag. It includes 12 needles (5" long and 3mm diameter) and has a one-year warranty. ■

Circle 125 on card or click "PTEN e-inquiry" on VehicleServicePros.com

### FEATURES TWO INTERCHANGEABLE ANVILS

The **Makita USA 18V LXT Cordless 3/8" / 1/4" Sq. Drive Ratchet Kit (XRW01SR1)** is a dual-purpose ratchet with two interchangeable anvils (3/8" and 1/4") that can be quickly changed out. It has 35 ft-lbs of fastening torque, yet it can deliver up to 800 rpm. It has variable speed with forward and reverse settings and an electric brake for increased convenience. For added efficiency, it can be used as a manual ratchet when the motor is not engaged. It's powered by the same fast-charging 18V batteries that are compatible with over 275 LXT cordless products. ■

Circle 126 on card or click "PTEN e-inquiry" on VehicleServicePros.com



### AVAILABLE IN 1/2" OR 3/4" ANVIL SIZE OPTIONS

The **Durofix 60V Cordless Brushless Jumbo Impact Wrenches**, Nos. RI60164 and RI60164-6, have two anvil size options: 1/2" (No. RI60164) and 3/4" (No. RI60164-6). The 1/2" impact wrench delivers up to 1,500 ft-lbs of maximum reverse torque and offers three pre-set torque stages (332, 450, and 1,000 ft-lbs). The 3/4" impact wrench has a maximum reverse torque of 1,605 ft-lbs and offers three pre-set torque stages (332, 450, and 1,070 ft-lbs). Both feature a built-in LED and battery power indicator. ■

Circle 127 on card or click "PTEN e-inquiry" on VehicleServicePros.com



### CONVERTS 1/4" DRIVE RATCHET INTO A HIGH-TORQUE HEX SCREWDRIVER

The ProMAXX PowerDrive Hex Adapter is designed to convert any type of 1/4" drive ratchet, including electric, air, and hand into a powerful, high-torque hex screwdriver. Its 1/2" tall profile allows users to reach limited access areas with an included straight-head or Phillips-head hardened-steel bit. Additionally, the adapter accepts any 1/4" security hex shank specialty bit. Made in the U.S.A. ■

Circle 128 on card or click "PTEN e-inquiry" on VehicleServicePros.com



### MEASURES 7.2" IN HEIGHT

The Chicago Pneumatic CP7741 1/2" Pneumatic Impact Wrench Series is ideal for operators working in tire changing applications. The CP7741 series, formally the CP7736 series, offers a free speed of 10,000 rpm, forward working torque range of 90 to 510 ft-lbs, and a maximum reverse torque of 715 ft-lbs. It also has three forward settings, and a composite handle for less heat transfer. Each tool measures 7.2" in height. ■

Circle 129 on card or click "PTEN e-inquiry" on VehicleServicePros.com



### HEAT-TREATED FOR STRENGTH AND DURABILITY

The ATD Tools 19-pc 1/2" Drive 6-Point SAE Deep Impact Socket Set, No. ATD-44419, is made of high-quality chrome-moly steel and is heat-treated for strength and durability. Sockets include: 3/8", 7/16", 1/2", 9/16", 5/8", 11/16", 3/4", 13/16", 7/8", 15/16", 1", 1-1/16", 1-1/8", 1-3/16", 1-1/4", 1-5/16", 1-3/8", 1-7/16", and 1-1/2". ■

Circle 130 on card or click "PTEN e-inquiry" on VehicleServicePros.com



FOR MORE INFORMATION ON THESE PRODUCTS, CLICK ON "PTEN E-INQUIRY" at VehicleServicePros.com OR CIRCLE THE NUMBER ON THE CARD.





# AIRCAT

## PNEUMATIC TOOLS

## 1/4" COMPOSITE RATCHET

### EXH800

### 35 ft/lbs MAX TORQUE

-  Most comfortable trigger lever in the industry.
-  320 RPM provides fast rundown.
-  Patented quiet tuned exhaust (82dba)
-  Feather trigger for control



# AIRCAT.COM

Circle 140 on card or click "PTEN e-inquiry" on VehicleServicePros.com

SPONSORED

Circle 141 on card or click "PTEN e-inquiry" on VehicleServicePros.com

## FEATURED PRODUCT

### FOR SERVICING ELECTRIC VEHICLES

**BendPak** worked with a leading electric car manufacturer to develop the **MDS-6EXT mid-rise lift** specifically to raise electric vehicles (EVs) for service. The MDS-6EXT extended lift platforms reach EV lifting points that are often on the extreme edges of the vehicle frame. Configurable approach ramps accommodate low-slung vehicles and those with large tires. Install above ground or sub-surface/flush. Its open center design provides unimpeded undercarriage access. Rated capacity is 6,000 lbs. ■



**BP BendPak**

**BendPak**  
800-253-2363  
bendpak.com

### CLAMPS TO VIRTUALLY ANY SURFACE

The **Streamlight BearTrap** is designed to provide high power and performance with bright white light in both spot and flood, each with high, medium, and low lighting modes. Clamps to virtually anywhere or stands on its own, the rechargeable worklight provides a handsfree lighting option and allows users to illuminate hard-to-get-to spaces such as under the dash. It also features a magnetic base, stowable hook, thermoplastic construction, and a chemical-resistant lens that withstands most common automotive chemicals. ■



Circle 142 on card or click "PTEN e-inquiry" on VehicleServicePros.com

### REMOVES GREASE, OIL, ADHESIVE, PAINT, AND MORE



The **Malco Products Apex Heavy Duty Cleaning Wipes** are designed for the automotive repair market. These dual-sided wipes clean heavy soils and scrub away grime on hard surfaces with one dual-sided towel while offering the versatility to be used on hands without causing drying or chapping. Made with a citrus-based lanolin formula, the wipes clean without leaving stains or residue. The wipes remove grease, oil, adhesive, paint, ink, tar, and food or drink spills. The wipes are large 7" by 10" towels available in a 130-count canister. ■

Circle 143 on card or click "PTEN e-inquiry" on VehicleServicePros.com

SPONSORED

Circle 144 on card or click "PTEN e-inquiry" on VehicleServicePros.com

## FEATURED PRODUCT

### COXREELS SAFETY TO THE NEXT LEVEL

Power up your safety with **Hi-Vis Hose** by **Coxreels**. Featured on P, SH, and T series, Hi-Vis Hose is a hybrid bright yellow hose with a white glossy stripe available in 3/8" and 1/2". Hybrid hoses (PVC + rubber blend) offer similar performance to rubber with the weight of PVC, combining positive features of both hose types. Adding EZ-Coil controlled retraction to your Hi-Vis Hose Coxreels reel will create the maximum safety environment. ■



**COXREELS**

**Coxreels**  
480-820-6396  
coxreels.com

### FEATURES AN EASY-TO-GRIP HANDLE

The **Sellars Absorbent Materials TOOLBOX Z400 Big Grip Shop Towels Dispenser** can be carried to any task with an easy-to-grip handle. The wall brackets allow the dispenser to be mounted to surfaces for convenient accessibility. The shop towels are made with 40 percent post-consumer recycled fibers and meet EPA comprehensive procurement guidelines. ■



Circle 145 on card or click "PTEN e-inquiry" on VehicleServicePros.com

# EXPAND YOUR CAPABILITIES

## Engineered for the Road Ahead

Today's customers expect the best service available, and Danmar's line of wheel service products surpass those expectations. Danmar's *advanced tire changers* and *easy-to-use wheel balancers* keep your customers returning. Whether you're starting a new business or expanding your shop's wheel service capabilities, Danmar has the best equipment that fits any budget.

*Danmar. Tried, true, trusted.*



Model DT-50A

**\$3,549**

FREE SHIPPING\*



Model DB-70

**\$2,483**

FREE SHIPPING\*

Circle 146 on card or click "PTEN e-inquiry" on VehicleServicePros.com

[www.danmar.com](http://www.danmar.com) • 877-432-6627

© 2022 BendPak Holdings LLC. A wholly owned subsidiary of BendPak, Inc.  
\*Free shipping applies to most destinations in the 48 contiguous United States.

**DANNMAR**  
A division of BendPak®

SPONSORED

Circle 147 on card or click "PTEN e-inquiry" on VehicleServicePros.com

## FEATURED PRODUCT



### UTILIZES DUAL HI-RES CAMERAS

Most borescopes use mirrors to achieve alternate viewing angles. **Cal-Van's** newest borescope, the **Dual Camera Wi-Fi Borescope**, No. 86, utilizes dual hi-res cameras, bright LED illumination, and up to three times zoom to give users superior viewing and video capture capabilities. Hi-res 1080p cameras provide front and side video and image capture. The camera, lens, and cable are IP67 rated for water resistance. Ultra-bright lighting provided by seven total LEDs. The unit transmits and connects to devices via an independent Wi-Fi signal, giving it the freedom to be used everywhere. ■



**Cal-Van Tools**  
800-537-1077  
cal-vantools.com



### INCLUDES A TOOLBOARD BACK WALL

The **Homak 72" RS Pro 3 Drawer Hutch w/Power Strip and Stainless Steel Top** measures 23-1/2" by 72" by 24-3/8" and weighs 254 lbs. Its body, frame, and drawers have a metal thickness of 16 gauge/1.5mm. The hutch features lift latch drawer pulls, a HMC high security tubular locking system, removeable ball bearing slides, EVA drawer liners and top mat, and full extension gas struts. It has UV protective finish and 3.2mil powder coat paint finish. Additionally, it includes a toolboard back wall, a power strip, and two USBs with four outlets and grommet cut-outs. Available in red, black, blue, orange, and green. ■

Circle 148 on card or click "PTEN e-inquiry" on VehicleServicePros.com

UP TO 80% SLOWER RETRACTION

# INNOVATING SAFETY

**COXREELS**

**EZ-COIL SAFEST REELS IN THE INDUSTRY.**  
PATENTED REWIND SYSTEM

- ✓ Eliminate dangerous whipping hazards.
- ✓ Requires no external power source.
- ✓ Wide array of reel models & options to increase worksite efficiency & safety.

**DURABLE. RELIABLE. HOSE, CORD, & CABLE PRO GRADE REELS**

► SOLUTIONS FOR: WATER | AIR | POWER | HYDRAULIC | PNEUMATIC | VACUUM | WELDING AND MORE

MADE IN THE USA SINCE 1923

[WWW.COXREELS.COM](http://WWW.COXREELS.COM)

f i in y

Circle 150 on card or click "PTEN e-inquiry" on VehicleServicePros.com

36 PTEN ○ JULY 2022 ○ www.VehicleServicePros.com

### BARRIER-FREE TOOL SELECTION

The **Shadow Tool Staging System TSS 6.5** is designed to simplify tool selection/return, saving technicians on time and reducing physical motions while making tool inventory control simple. The TSS



6.5 openly presents tools in dedicated positions, allowing visual cues and barrier-free tool selection. The compact system measures 6'5" height by 30" depth by 36" width and sits on 8" wheels. The unit expands with large panels sliding out to 90" in width, exposing shelves, custom accessories, power (110, USB, 12V), a battery charging drawer, and laptop mounting options. ■

Circle 149 on card or click "PTEN e-inquiry" on VehicleServicePros.com



### INCLUDES LARGE TOOL TRAY

The **Viking Adjustable Mechanic's Rolling Stool**, No. 57104, features high-density foam to provide maximum comfort for all-day use and a large tool tray to keep parts within reach. With a hydraulic piston, the stool adjusts from 15.6" to 20.4". The five professional-grade polyurethane swivel casters resist corrosion and are designed to provide easy movement even over cords, cracks, and debris. Made from heavy duty construction, the stool supports up to 300 lbs and its upholstery is resistant to most shop chemicals. ■

Circle 151 on card or click "PTEN e-inquiry" on VehicleServicePros.com



FOR MORE INFORMATION ON THESE PRODUCTS,  
CLICK ON "PTEN E-INQUIRY"  
at [VehicleServicePros.com](http://VehicleServicePros.com)  
OR CIRCLE THE NUMBER ON THE CARD.

## SECURELY HOLDS TOOLS IN PLACE

The **Mantis Toolgrid** is a series of patented tool holders and boards designed to organize and securely hold tools in place. Locating pins on the bottom of each holder fit into the holes of the Toolgrid board for a quick and easy set-up. The thousands of holes in each board gives users infinite layout possibilities. Once a set-up is complete the holders are secured to the boards with specially formulated T20 screws. ■



Circle 160 on card or click "PTEN e-inquiry" on [VehicleServicePros.com](http://VehicleServicePros.com)



## ATTACHES TO MOST FERROUS SURFACES

The **Matco Tools 4 and 12 Slot Magnetic Wrench Racks** hold wrenches from 10mm to 19mm. Made from non-marring TPR material, the racks are built to be used in all work and storage areas without worry of the holder scratching or denting surfaces. While being ultra-flexible to bend on virtually any ferrous surface, the strong embedded magnets will hold wrenches tight and prevent them from moving around in the toolbox drawer, on the tool cart, or even under the hood. The magnetic racks feature a low-profile design, withstand most automotive fluids, and are easy to clean. They also have a modular magnetic design, allowing users to align two or more sets together. ■

Circle 161 on card or click "PTEN e-inquiry" on [VehicleServicePros.com](http://VehicleServicePros.com)



## 14-GAUGE STEEL FRAME

The **Carlyle Tools 3500 Series 72" Bottom Roller Chest** is constructed with a 14-gauge steel frame, 16-gauge steel drawers, and six heavy duty spring-loaded casters (9,000 lbs capacity). The tool chest is 30" deep with a power tool drawer equipped with a power bank. The 3500 series has two separate power banks totaling eight outlets and four fast-charging USB ports. The drawers feature 240-lbs ball-bearing slides with lift-lock drawer pulls. It comes in reflex blue and jet black. ■

Circle 162 on card or click "PTEN e-inquiry" on [VehicleServicePros.com](http://VehicleServicePros.com)



**OEM TOOLS**  
FAST IN CLASS

# COVERED

## CHILL...

### OEMTOOLS HAS YOU COVERED!



## FANS ON SALE NOW!

Scan QR code or search  
<http://bit.ly/PTENJuly22>  
to get deals on all  
OEMTOOL Fans.



Circle 163 on card or click "PTEN e-inquiry" on [VehicleServicePros.com](http://VehicleServicePros.com)

SPONSORED

Circle 164 on card or click "PTEN e-inquiry" on VehicleServicePros.com

## FEATURED PRODUCT

### FEATURES A LOW PROFILE AND LONG REACH

Newly introduced by **Ascot Supply Corporation**, this **3-Ton Floor Jack** features a low profile and long reach to access virtually all spaces. With its double pump design, you can expect the highest efficient and an ultra-quick lift. It makes use of two extra-wide casters and two swivel casters with bearings for stability and easy mobility. The jack also has overload and bypass devices to prevent the technician from using beyond the rated capacity and overextending the ram. Its sealed hydraulic unit prevents contamination and U-joint release for precise load control in any handle position. The handle is one-piece steel construction. For handsfree positioning, the lift has a convenient foot pedal. ■



Ascot Supply Corporation



### AUTO SHUT-OFF WHEN RECOVERY IS COMPLETE

The **JB Industries F6-BOOST BLDC Ignition-Proof Refrigerant Recovery Unit** is designed to provide users fast, reliable refrigerant recovery of ARHI groups III, IV, and V refrigerants. Its two-cylinder, oilless compressor and long-lasting pistons are housed in a light-weight, ergonomically designed unit. It features built-in purge functionality, a non-pressurized vented crankcase, an auto shut-off, status indicator light, and an easy-to-use interface. ■

Circle 165 on card or click "PTEN e-inquiry" on VehicleServicePros.com



## DB-8000-XL



Dual air cylinder strut compressor used by many performance and 4X4 off-road businesses. It can handle the repeated use by production shops and suspension manufacturers. QSP had it independently tested. Look at the results!

PSI	LBF (Imperial)	N (Metric)
80	2,927	13,020
100	3,325	14,790
120	4,023	17,895
140	4,700	20,907

Approved equipment by most OEMs.

www.qsponline.com  
888.743.5378



### IDEAL FOR COMPACT SPACES

The **Portacool Evaporative Cooler**, No. 510, features a small footprint and can be easily moved around. Equipped with Kuul Control MicroTech evaporative media, oscillating louvers, a discrete manual fill door, a low-water shutoff, and sturdy casters, the Portacool 510 is designed to provide maximum cooling comfort. It measures 35" in height by 20" in width and 19" in depth, and has an 8 gallon water reservoir. It also has sturdy, rubberized wheels for quiet movement. No assembly required. ■



Circle 167 on card or click "PTEN e-inquiry" on VehicleServicePros.com



### FEATURES A 360-DEGREE SWIVEL BASE

The **Ken-Tool Industrial Duty Bench Vise** is made from high-strength Austempered ductile iron, providing durability and long-life use. Its micro-grooved, replaceable steel jaws have a hardness of HRC45-56. The pipe jaws provide a solid grip on pipe and other rounded material. Features a 360-degree swivel base, and a U-shaped collar screw design for wear-resistance and smooth operation. These vises have 4", 5", 6", and 8" jaw widths. The gear-type locking system with double lock-down bolts locks the vise securely in position. ■

Circle 168 on card or click "PTEN e-inquiry" on VehicleServicePros.com

# SPRING SAVINGS

# SALE!

Prices valid until July 31<sup>st</sup>, 2022

**ONLY**

**\$8,265**  
~~\$8,815~~

**BendPak XPR-12CL**  
12,000 lb. Capacity  
Clearfloor Two-Post  
#5175405

- Max. Rise: 69"
- Width: 155"
- Height: 170"



**DON'T MISS THESE SAVINGS!**

**\$875**  
VALUE

**INCLUDES**  
16-pc. Adapter Set



**BP BendPak.**

**ONLY**

**\$5,605**  
~~\$5,955~~

**BendPak MDS-6EXT**  
6,000 lb. Capacity  
Mid-Rise Scissor Lift  
#5175192

- Lifting Platform: 19" x 78.7"
- Lifting Height: 36.75"



**BP BendPak.**

**ONLY**

**\$7,060**  
~~\$7,460~~

**BendPak HD-7PXW**  
7,000 lb. Capacity | Super-Tall Rise 4-Post Lift  
#5175516



**SUPER-TALL**



**BP BendPak.**

- Max. Rise: 140"
- Width: 110.25"
- Length: 224.5"

**ONLY**

**\$2,295**  
~~\$2,470~~

**Ranger RML-1500XL**  
Extended Motorcycle Lift  
#5150605

- Lifting Capacity: 1,500 lbs.
- Height: 7.75" - 45"

- Table Width: 30" - 53"
- Table Length: 89" - 102"



**R Ranger.**

**ONLY**

**\$1,250**  
~~\$1,495~~

**BLOWOUT SALE!**

**Cool Boss CB-30L**  
Portable Evaporative  
Air Cooler  
#5150551



- Fan Diameter: 30"
- Max. Airflow: 10595 CFM
- Power Supply: 110V / 60Hz / 1 Ph

**COOL BOSS**

**ONLY**

**\$3,220**  
~~\$3,320~~

**Ranger DST642D**  
Wheel Balancer  
#5140153

- Max. Wheel Diameter: 10" - 30"
- Max. Tire Diameter: 50"

**FREE**  
WHEEL WEIGHT  
STARTER KIT



**R Ranger.**

**ONLY**

**\$2,310**  
~~\$2,410~~

**Ranger R745**  
Swing Arm  
Tire Changer  
#5140148

- Internal Clamping: 12" - 20"
- External Clamping: 10" - 16"
- Maximum Tire Diameter: 36"



**R Ranger.**



**ONLY**

**SALE PRICE**

**\$9,533**

**CPS FX3030**  
Dual Gas Ac Machine  
Refrigerant Management System  
#6010302

- Compressor: 2/3 HP CC Twin Cylinder Oil-less
- Refrigerant: R-134a / R1234yf



- Vacuum Pump: 50 Micron Rated 6 CFM
- Ergonomic Design
- Digital Displays

**cps**

**Call 1-800-261-7729 or visit [WWW.WRENCHERS.COM](http://WWW.WRENCHERS.COM)**

© 2022 Wrenchers LLC. All Rights Reserved. Free shipping applies to the 48 contiguous United States only.

Circle 169 on card or click "PTEN e-inquiry" on VehicleServicePros.com

SPONSORED

Circle 170 on card or click "PTEN e-inquiry" on VehicleServicePros.com

## FEATURED PRODUCT

### FEATURES A COMPACT DESIGN AND SMALL FOOTPRINT

The **OMER USA IPPO 45 Double Scissor Lift** is ALI certified and rated at 10,000 lbs.

The IPPO 45 retains a compact design and small footprint.

The lift is ideal for shops with high lift-cycles or heavy vehicles in quick service bays, lube shops, and dealerships. It's engineered to the highest safety standard. Both platforms are equipped with mechanical safety locks with 21 locking positions. With the IPPO 45, shops can expand their capabilities and decrease downtime. ■



**OMER Lifts**  
470-275-5919  
omerinc.com



### AVAILABLE IN 30' TO 50' CORD LENGTH OPTIONS

The **General Manufacturing Saf-T-Lite Commercial Power Supply Reels** include a mounting bracket and hardware for easy setup. Available in 30' to 50' cord length options and 18/2 to 16/3 gauge cord options, the power supply reels are designed for any high volume automotive repair facilities. Triple outlet with circuit breaker and Saf-T-Lok also available. The power supply reels have 9" diameter steel construction and 7A to 10A capacity. ■

Circle 171 on card or click "PTEN e-inquiry" on VehicleServicePros.com

## Switch to Induction Heat

### APPLICATIONS:

- > Calipers
- > Lug Nuts
- > Rusted Bolts
- > Vinyl Graphics
- > and 100's more!



### Mini-Ductor® VENOM® HP

The Venom HP is the highest powered Mini-Ductor handheld induction heater available at **1800** watts of power. Allows users to heat metal components faster than ever before! Manufactured with genuine OEM parts. *More precise, safe and reliable than a torch.*

*This tool is manufactured in the USA with genuine OEM parts. Available through your local tool distributor.*



**INDUCTION INNOVATIONS**  
www.theinductor.com  
877-688-9633



Follow Us on Social Media:



Circle 172 on card or click "PTEN e-inquiry" on VehicleServicePros.com  
40 PTEN © JULY 2022 © www.VehicleServicePros.com

### MAXIMUM LIFT HEIGHT OF 38"

The **LiftMaster 7000** from **LiftWise** allows users to lift or lower a variety of parts into position for maintenance or other needs. Featuring a high lift capacity with a compact and maneuverable design, the hydraulic lift table provides easy operation for demanding operational tasks. The LiftMaster 7000 has a lift-off capacity of 5,500 lbs and a full capacity of 7,000 lbs. A pump handle is used to precisely raise/lower the table with a maximum lift height of 38". The lift is 32" wide and 72" long with the handle raised. The handle can be folded for a storage height of just 10.5". An optional bolt-on transfer top is available. ■



Circle 173 on card or click "PTEN e-inquiry" on VehicleServicePros.com

### ABSORBS AND RETAINS OIL, COOLANTS, AND MORE

The **SpillTech Commander Mat Mini-Roll, No. GRSF1550S**, quickly soaks up drips, spills, and splatters. The roll safely absorbs and retains oil, coolants, water, grease, gasoline, solvents, auto fluids, paint overspray, battery acid, and most other liquids. It's also free of grit and dust, making it ideal for use around delicate sensors, parts, and tools. ■



Circle 174 on card or click "PTEN e-inquiry" on VehicleServicePros.com



FOR MORE INFORMATION ON THESE PRODUCTS,  
CLICK ON "PTEN E-INQUIRY"  
at [VehicleServicePros.com](http://VehicleServicePros.com)  
OR CIRCLE THE NUMBER ON THE CARD.



### 10" DEEP DRAWER SUPPORTS UP TO 200 LBS

The **Cornwell Quality Tools Elite Series 29" 5-Drawer Roller Cabinet** features 6" by 2" casters, full-length drawer pulls, tubular key lock, drawer liners, an end handle, and a work surface top mat. The 4" and 6" drawers are able to support up to 120 lbs, and the 10" deep drawer is able to support up to 200 lbs. Each caster is able to support 600 lbs. ■

Circle 175 on card or click "PTEN e-inquiry" on [VehicleServicePros.com](http://VehicleServicePros.com)

SPONSORED

Circle 176 on card or click "PTEN e-inquiry" on [VehicleServicePros.com](http://VehicleServicePros.com)

## FEATURED PRODUCT

### AVAILABLE IN A WIDE VARIETY OF SIZES AND COLORS

Versatility is a must for organizing any socket set. Capitalize on maximum possibilities with **Ernst Manufacturing's Socket Boss**. Add or remove socket clips, label socket sizes with I.D. stickers, trade colors, swap out drive sizes, add ratchet and extension holders;

the options are limitless for organizing your own set of sockets. Also features compact storage, portable design, and secure Twist-Lock clips. Available in a wide variety of sizes and colors. Made in the U.S.A. and has a lifetime guarantee. ■



**ERNST**  
— MANUFACTURING INC. —

Ernst Manufacturing, Inc.  
877-376-7885  
[ernstmfg.com](http://ernstmfg.com)



## CAT COMPLETE™ Fuel, Exhaust & Emissions System Cleaner

### Innovation in a bottle.

Within one year, this product has become a worldwide bestseller.

- Complete Fuel, Exhaust & Emissions Cleaner
- Cleans & Restores Catalytic Converter
- Increases power, performance, mileage and saves gas by not only cleaning the entire emissions & exhaust system, but the fuel system as well. Works with gasoline, ethanol and hybrid vehicles.
- Regular use every 5,000 miles optimizes fuel, emissions and exhaust systems, keeping them clean and preventing any Check Engine Lights (CELs). This also saves on expensive fuel system and emission control repairs.
- Pass Emissions Smog Test, Guaranteed

[cel-reset.com](http://cel-reset.com)



- ✓ RESTORE POWER & PERFORMANCE
- ✓ PASS EMISSIONS SMOG TEST
- ✓ DEODORIZES SMELLY EXHAUST



**CAT COMPLETE™  
FUEL,  
EXHAUST &  
EMISSIONS  
SYSTEM  
CLEANER**

**CHECK ENGINE LIGHT MEDIC™**  
Pass Emissions Smog Test, Guaranteed

- ✓ Turn Off Check Engine Light
- ✓ Clear P0420 & Other OBD Codes\*
- ✓ Cleans & Restores Catalytic Converter
- ✓ Reduces Emissions & Saves Gas

\*RISLONE cannot detect or identify light bulbs, sensors, or other electrical malfunctions. Always CONSULT a mechanic for advice.

16.9 FL. OZ. (500 mL)

Part #4720

Circle 177 on card or click "PTEN e-inquiry" on [VehicleServicePros.com](http://VehicleServicePros.com)

SPONSORED

Circle 178 on card or click "PTEN e-inquiry" on VehicleServicePros.com

## FEATURED PRODUCT



### SPLITS ANY AIR LINE INTO FOUR SEPARATE LINES

Ascot Supply's 4-Way Inflator Kit allows to split any air line into four separate lines. It boasts a tough and compact footprint, yet lightweight design, which makes it a top contender. It is ideal for transporting with ease to any shop or off-road worksite. The quick coupler connects directly to the inflator. It also has a slide valve to control the air supply and turn on/off and features a lightweight aluminum manifold. The kit includes four 25' hoses complete with connections. ■

**ASCOT**  
Supply Corporation

Ascot Supply Corporation



### CUTS 99 PERCENT OF CONTEMPORARY AUTOMOTIVE KEYS

The XToolUSA Triton PLUS Automotive Edition is designed to cut 99 percent of contemporary automotive keys. The package includes an additional jaw for cutting tibbe keys, along with cutters and decoders necessary for plastic emergency keys, dimple keys (Nissan), and the latest edge-milled VW high-security keys. ■

Circle 179 on card or click "PTEN e-inquiry" on VehicleServicePros.com

SPONSORED

Circle 181 on card or click "PTEN e-inquiry" on VehicleServicePros.com

## FEATURED PRODUCT



### DESIGNED TO FIT OVER ANY OIL CHANGE PIT

The TraXion Oil Change Creeper is designed to fit over any oil change pit safely due to its wide stance. To use properly, position the creeper into the desired place around your vehicle and secure with two locking casters. The creeper features a padded deck that allows for productivity over longer periods of time and will allow technicians to work inside engine bay safely. The product folds flat for compact storage. ■

**TRAXION**  
engineered products

TraXion Engineered Products  
479-474-3460  
traxionproducts.com



### PREVENTS CROSS-CONTAMINATION

The **Yellow Jacket TurboRecover Recovery Machine** is a fully automatic operation for fast recovery of Class III, IV, and V refrigerants including R-410A and A2L refrigerants. The twin-cylinder, oil-less compressor and 1.25hp brushless DC motor ensures fast recovery of every system, the company says. Its dual-gauge design allows for monitoring of the system and tank pressures simultaneously and its integrated low-pressure switch automatically powers down the machine when the system reaches 10" of vacuum. The purge circuit clears residual refrigerant from the machine, preventing cross-contamination when changing from one refrigerant to another. With a lightweight design and included shoulder strap, the unit is easy to transport around the shop. ■

Circle 180 on card or click "PTEN e-inquiry" on VehicleServicePros.com

### DOUBLE BARREL INTERNAL LOCKING SYSTEM

The **SP Tools USA Diagnostic Cart**, No. SP44550LG, features four drawers, a 27" Spectre curved monitor, and a spacious lower compartment. It measures 34" in length, 24" in width, and 62.25" in height (when closed). It's made from 14.5 gauge steel, has an internal locking system for extra security, and a SP Kliklok drawer locking system to ensure drawers stay closed. ■

Circle 182 on card or click "PTEN e-inquiry" on VehicleServicePros.com





FOR MORE INFORMATION ON THESE PRODUCTS,  
CLICK ON "PTEN E-INQUIRY"  
at [VehicleServicePros.com](http://VehicleServicePros.com)  
OR CIRCLE THE NUMBER ON THE CARD.



## OFFERS BOTH A LIFT AND SLIDE TOP LID

The **Mechanic's Time Savers Switch Cart** can be opened by sliding or flipping open, allowing users to utilize the top as a work surface while still being able to access their tools by sliding open. The cart measures 36" in width by 26" in depth by 45" in height. The top lid has 175-lb slides, the three drawers have 125-lb slides, and the lift-latch drawer pulls. The cart has 6" casters, heavy duty construction, and a power strip. It's available in three trim colors: black, red, and yellow. ■

Circle 183 on card or click "PTEN e-inquiry" on [VehicleServicePros.com](http://VehicleServicePros.com)

## STORES AND ORGANIZES 75 SAE AND METRIC SOCKETS

The **OEMTOOLS 6-Pack Set Metric and SAE Magnetic Socket Organizers**, No. 22488, are ideal for tool organization, as they are designed to fit snug into tool chests. All six socket organizers fit both deep and shallow sockets. The set comes with three organizers with metric markings and three with SAE markings. They are able to store and organize a total of 75 SAE and metric 1/4", 3/8", and 1/2" drive sockets without spills, as each one has a strong magnetic non-marring, rubberized base. The organizers are available in either a red or blue color. ■

Circle 185 on card or click "PTEN e-inquiry" on [VehicleServicePros.com](http://VehicleServicePros.com)



## INCLUDES 22 MODELS

The **Jenny Products Electric Two-Stage, Horizontal-Tank Stationary Air Compressor Line** features heavy duty cast-iron compressor pumps and is suited for applications requiring greater pressure. The line displaces between 9.1 and 107 cfm at 175 psi. Made in the U.S., the line of 22 belt-driven models provides an extensive range of size and power options, with ASME certified tank sizes spanning from 60 to 240 gallons. ■

Circle 186 on card or click "PTEN e-inquiry" on [VehicleServicePros.com](http://VehicleServicePros.com)

SPONSORED

Circle 184 on card or click "PTEN e-inquiry" on [VehicleServicePros.com](http://VehicleServicePros.com)

## FEATURED PRODUCT

### CUSTOM CONFIGURATIONS

The **Steck Manufacturing Pro Folding Parts Cart**, No. 35950, is a versatile parts cart with locking pin fasteners that allow each shop to custom configure up to three shelves/mesh baskets vertically or flip for dual-sided access. Additionally, mesh baskets can be added as needed, as well as cart hooks to hang bumpers, hoods, fenders, and other components. Wide 4" polyurethane casters attached to telescopic legs (29.7" to 45.7") allow the cart to easily support up to 396 lbs. ■



**Steck Manufacturing**  
937-222-0062  
[steckmfg.com](http://steckmfg.com)

## STORES AND ORGANIZES 75 SAE AND METRIC SOCKETS

The **OEMTOOLS 6-Pack Set Metric and SAE Magnetic Socket Organizers**, No. 22488, are ideal for tool organization, as they are designed to fit snug into tool chests. All six socket organizers fit both deep and shallow sockets. The set comes with three organizers with metric markings and three with SAE markings. They are able to store and organize a total of 75 SAE and metric 1/4", 3/8", and 1/2" drive sockets without spills, as each one has a strong magnetic non-marring, rubberized base. The organizers are available in either a red or blue color. ■

Circle 185 on card or click "PTEN e-inquiry" on [VehicleServicePros.com](http://VehicleServicePros.com)



SPONSORED

Circle 187 on card or click "PTEN e-inquiry" on [VehicleServicePros.com](http://VehicleServicePros.com)

## FEATURED PRODUCT

### FUMECADDIE - PORTABLE VEHICLE EXHAUST EXTRACTOR

The FumeCaddie is excellent for any auto mechanic repair shop or full-service auto dealership repair center, the purpose of the **Plymovent FumeCaddie** is used to capture exhaust fumes at the source emitted by any vehicle or apparatus running indoors and extract them from the building. The FumeCaddie is directly connected to the vehicle or apparatus tailpipe with an easy-to-use nozzle. ■



**PLYMOVENT**<sup>®</sup>  
clean air at work *Since 1975*

**Plymovent Corporation**  
800-644-0911  
[plymovent.com/us](http://plymovent.com/us)

SPONSORED

Circle 188 on card or click "PTEN e-inquiry" on VehicleServicePros.com

## FEATURED PRODUCT

### HAS A BUILT-IN 5W WIRELESS SPEAKER

**SABER** lighting has introduced a floodlight with a built-in 5W speaker, the **ATD-80211**. Its unique design features a spring-loaded clamp with powerful magnets, providing technicians multiple options for secure mounting. The COB LED can be adjusted from 100 to an incredibly bright 1,000 lm. The great-sounding, integrated 5W speaker plays from your Bluetooth-enabled devices and has a range of 40'. The rechargeable Li-ion battery lasts up to 15 hours. ■



**SABER**

ATD Tools, Inc.  
atdtools.com

### FOR STANDARD AND HYBRID VEHICLES

The **FCAR Tech AC400 Dual A/C Service Machine** features a 99-percent recovery efficiency for standard and hybrid vehicles, and boasts fully automatic function. The unit will recover, recycle, evacuate, leak test, and recharge R-134a and has automatic refrigerant refill and oil drain/inject. The A/C unit includes a comprehensive A/C capacity database, onboard electronic scales, a built-in thermal printer, an internal tank, and a vacuum leak test. Its auxiliary functions include vacuum system piping, multiple alarms, maintenance procedures, and part inspections. ■



Circle 189 on card or click "PTEN e-inquiry" on VehicleServicePros.com

## THE RIGHT TOOLS FOR THE JOB

**ULINE**  
SHIPPING SUPPLY SPECIALISTS



ORDER BY 6 PM FOR  
SAME DAY SHIPPING

COMPLETE CATALOG  
1-800-295-5510 uline.com

### FOR MEDIUM AND HEAVY DUTY TRUCKS

The **AME International JACKZILLA Premium 20-Ton Air/Hydraulic Bottle Jack**, No. 14455, is designed for tire changing applications on commercial fleets, agricultural, construction, and maintenance equipment. It comes with a 10" by 10", 50-ton jack plate for optimal weight displacement on uneven or non-compacted surfaces as well as a Flexzilla hose assembly. Additionally, the unit has an in-line regulator that limits inlet pressure to 94 psi to prevent air bypass. ■



Circle 191 on card or click "PTEN e-inquiry" on VehicleServicePros.com

### IDEAL FOR ABSORBING GREASE AND OIL



The **Shopserve Microfiber Towels** from **Hospesco Brands Group** are thin but durable 12" by 12" towels that are ideal for quickly removing dirt, dust, and bacteria from surfaces requiring little to no chemicals. Available in a convenient dispensing box, the microfiber cleaning towels can be kept in areas where cleaning up or wiping down surfaces is a more constant undertaking. The towels are disposable or can be machine washed for limited reuse. They also excel at absorbing grease and oil. ■

Circle 192 on card or click "PTEN e-inquiry" on VehicleServicePros.com

◀ **INTRODUCING** ▶

# The All New MaxJax® Portable Car Lift

**Start Saving Now!**



Valid until August 31, 2022. Discount good for MaxJax Standard, Deluxe, Supreme or Ultimate Package orders only.

**Fits in Low-Ceilings**

The MaxJax portable two-post lift is one of the most versatile DIY tools ever invented. Its patented design allows you to get full-sized lift advantages in spaces with limited ceiling heights. Best of all, MaxJax is completely portable and can be setup virtually anywhere. For more info call **1-844-629-5291** or visit **www.MaxJax.com**.

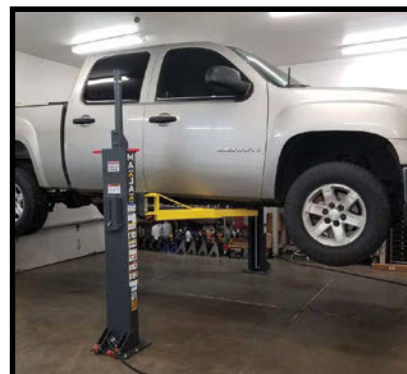
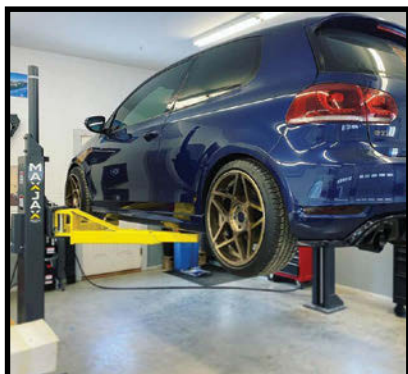

Circle 193 on card or click "PTEN e-inquiry" on VehicleServicePros.com

**1-844-629-5291 • www.MaxJax.com**

©2022 MaxJax, LLC, a subsidiary of BendPak Inc.

**MAXJAX®**

The MaxJax is protected by one or more patents or claims of patents in the U.S. and elsewhere. PATENT NO. US 8,256,577 B2 - PATENT NO. US 9,150,395 B2.

SPONSORED

Circle 194 on card or click "PTEN e-inquiry" on VehicleServicePros.com

## FEATURED PRODUCT



### COMPATIBLE WITH ALL EV AND HYBRID PLUG-IN VEHICLES

This **Autel MaxiCharger** is a 240V-50A, Level 2, EV smart charger that is compatible with all EV and hybrid plug-in vehicles. It features a sleek design with in-body holster built for indoor or outdoor hardwire installation. The MaxiCharger offers adjustable battery charging up to 50A and features a 25' long universal (J1772) cable. Use the Autel Charge app on your mobile device to remotely schedule, start, or stop charging. ■

# AUTEL®

**Autel**  
855-288-3587  
autelenergy.us/



### FOR MOST COMMON BATTERIES

The **OEMTOOLS 6-pc Battery Service Kit**, No. 25110, features the tools needed for service and maintenance for most common batteries. The kit includes a battery terminal puller, four-way post cleaner, 5/16" and 10mm battery terminal wrench, battery nut pliers, extended 5/16" battery terminal wrench, and a side terminal brush. All tools are packed into a heavy duty, roll-up sleeve for easy storage, organization, and transport. ■

Circle 195 on card or click "PTEN e-inquiry" on VehicleServicePros.com

### FIELD RATED TO 25 MICRONS

The **Yellow Jacket BULLET DC Vacuum Pump** features a brushless DC (BLDC) motor, capable of providing high torque and high efficiency. The unit functions in extreme low voltage conditions and is field rated to 25 microns. The easy-to-carry, lightweight design is available in 7 cfm to handle most residential and commercial applications. Pulling down to less than 25 microns, BULLET DC protects the system from contaminants and non-condensable gases, which can damage components, reduce efficiency, and cause system failure. ■

Circle 196 on card or click "PTEN e-inquiry" on VehicleServicePros.com



### QUICKLY RESCUES THE VALVE COVER

The **ProMAXX Valve Cover Saver Repair Kit** enables technicians to quickly and easily rescue the valve cover when faced with broken ignition coil hold-down bolts on Ford 3.5L EcoBoost and 5.0L Coyote engines. The patented system attaches directly to the plastic valve cover. Special machine-grade tooling enables technicians to drill dead center on broken or corroded ignition coil bolts and allows them to bring the cover back to a like-new condition. The system is available in three versions (ProKit, ProKit Plus, and ProView) and includes a flexible, scoping, and wireless digital camera that can also be used in additional scenarios, such as exhaust manifold procedures and EGR repairs. ■

Circle 198 on card or click "PTEN e-inquiry" on VehicleServicePros.com

### DESIGNED TO PROVIDE UP TO 100A OF POWER

The **Clore Automotive Pro-Logix**, No. PL6800, is designed to provide stable power, on-demand up to 100A, to a vehicle electrical system to support module reprogramming.

It's also designed specifically for fleet service battery charging with a maximum charge rate of 100A to quickly bring 4- and 8-battery Group 31 packs back to full charge. In power supply mode, the unit provides power to maintain vehicle electrical system voltage at a preset level, increasing its output in response to system load increases to maintain a stable power environment for successful reprogramming. It features a voltage output range of 13.1 to 14.9V, adjustable in 0.1V increments allowing the operator to dial the output in. ■

Circle 197 on card or click "PTEN e-inquiry" on VehicleServicePros.com





FOR MORE INFORMATION ON THESE PRODUCTS,  
CLICK ON "PTEN E-INQUIRY"  
at [VehicleServicePros.com](http://VehicleServicePros.com)  
OR CIRCLE THE NUMBER ON THE CARD.



### SMART SYSTEMS DETECTION

The **OTOFIX BT1 Battery Tester** provides a comprehensive battery diagnostics and repair solution that fits in the palm of the user's hand. Featuring a smart 5.5" touchscreen, the BT1 is able to examine battery and electrical systems as well as register a new battery. The battery tester also features OTOFIX's cloud services to access the latest support issues and solutions, advanced testing methods, BMS reset, and smart systems detection. It has a voltage range from 1.5V to 36V, and a CCA range of 100 to 3,000A. ■

Circle 199 on card or click "PTEN e-inquiry" on [VehicleServicePros.com](http://VehicleServicePros.com)

### JUMP STARTS 10-CYLINDER GAS OR DIESEL ENGINES

The **Schumacher Electric ProSeries 4000 Peak Amps 12V Lithium Portable Jump Starter**, No. DSR164, features dual internal lithium batteries that deliver 4,000

peak amps of power, enabling the device to jump start 10-cylinder gas or diesel engines. It incorporates both pre-

heating technology for jump starting in cold climates and pre-boost technology for deeply

discharged batteries. It also offers a front-facing worklight, and is able to charge USB devices.

The copper cables are 4-gauge and measure 30" in length. ■

Circle 224 on card or click "PTEN e-inquiry" on [VehicleServicePros.com](http://VehicleServicePros.com)



### CAPABLE OF 45 JUMP STARTS ON A SINGLE CHARGE

The **TOPDON JumpSurge3000** is a 3,000 peak amp jumpstarting tool and power bank for vehicles on and off the road. Supports vehicles with 12V batteries on up to 9L gas engines and 7L diesel engines. Capable

of 45 jump starts on a single charge, the JS3000 also has a boost function for difficult jumps and provides fast charging for devices such as laptops, cell phones, and more. Additionally, it features a 400 lm LED flashlight, sturdy outer housing that resists water, dust, and wear, as well as has a stop spark sensor that suspends its use after too many jumps in a 10 minute period. ■

Circle 225 on card or click "PTEN e-inquiry" on [VehicleServicePros.com](http://VehicleServicePros.com)



### URNS OFF CHECK ENGINE LIGHTS

The **Rislone Cat Complete Fuel, Exhaust and Emissions System Cleaner**, No. 4720, is an easy-to-install, cost-effective chemical solution to help customers pass emissions smog tests, turn off check engine lights, clear OBD codes, improve vehicle performance, and save gas. Simply add to half a tank of gas to clean the vehicle's entire fuel, exhaust and emissions system. Cat Complete uses a proprietary blend of heavy duty detergents

and solvents to remove contaminants, soot, carbon build-up, and oily residue from the fuel injectors, combustion chambers, turbo, catalytic converters, oxygen sensors, and exhaust. ■

Circle 202 on card or click "PTEN e-inquiry" on [VehicleServicePros.com](http://VehicleServicePros.com)

### AUTO-SHUTOFF FEATURE CONSERVES BATTERY LIFE

The **Allstart Updated Micro-Boost Jump Starter and Charger**, No. 540, features a new compact and rugged

design and offers 15 percent more power

than the company's previous 540 model. It's ideal for use on virtually

all V6 gas powered engines. The unit weighs under a pound, has a quick charge output, and automatically shuts off to conserve battery

life. Additionally, it has clamps with 100 percent copper inserts and anti-spark protection, and a bright LED flashlight. ■

Circle 203 on card or click "PTEN e-inquiry" on [VehicleServicePros.com](http://VehicleServicePros.com)



## Expand Your Testing Arsenal!

### #146 54 Pc. Test Connector Kit

- Connects to DMM's and Scopes
- *Wide coverage quickens the test process.*
- Applies to Foreign and Domestic Autos, Heavy Duty, Marine RV and Equipment.



Call 800-227-1603 for more info. - [www.esitest.com](http://www.esitest.com)



Circle 204 on card or click "PTEN e-inquiry" on [VehicleServicePros.com](http://VehicleServicePros.com)

SPONSORED

Circle 205 on card or click "PTEN e-inquiry" on VehicleServicePros.com

## FEATURED PRODUCT

### BRAKE LINE GAME CHANGER

**AGS's NiCopp EZ-FIT Complete Brake Line Replacement Kits** are an efficient alternative to pre-bent brake line kits. Each application specific kit comes with all the lines cut to length and flared with the correct tube nuts. Rust resistant NiCopp tubing bends easily and gives you the opportunity to run alternate routes without removing body mounts, exhaust components, or fuel lines. Additionally, they are packaged in "pizza boxes" and don't take up the space or shipping costs of traditional pre-bent packages. Available for the popular GM, Chevy, Ford, Jeep, Dodge trucks, and SUV applications. ■



**AGS** CO.  
AUTOMOTIVE SOLUTIONS®

**AGS Company**  
800-253-0403  
agscompany.com



### FEATURES A UNIVERSAL DESIGN

The **OTC Ball Joint Remover**, No. 6661, is designed to separate mainly the lower ball joint from the steering knuckle. Its universal design fits many applications, including various 2003 and later Chrysler vehicles. ■

Circle 207 on card or click "PTEN e-inquiry" on VehicleServicePros.com

SPONSORED

Circle 208 on card or click "PTEN e-inquiry" on VehicleServicePros.com

## FEATURED PRODUCT

### CREATES A HANDS-FREE, LEAK-FREE CONNECTION

From the company that created the Locking Grease Coupler comes a new innovation in tire inflation. The **LockNPlate Air Chuck** features six spring-loaded jaws that interlock with the threads on any Schrader valve to create a hands-free, leak-free connection. Rated to 150 psi, this chuck will not leak or pop off and comes in both open and closed flow options for different air systems. Available exclusively from LockNLube distributors and at locknlube.com. ■



**LOCKN LUBE**®

**LockNLube**  
603-795-2298  
locknlube.com



### FITS STRUT RODS UP TO 9/16" IN DIAMETER

The **Thexton Magnetic Strut Rod Lock**, No. 939, is an upgrade to the company's Hood/Tailgate Prop, No. 430. It fits strut rods up to 9/16" in diameter, and a magnet has been added in the base to now allow for one-handed applications. The tool securely attaches to a strut rod and holds hoods, trunks, or tailgates in place. It's made in the U.S.A. from lightweight aluminum, and the soft load bolt will not damage the strut rod, the company says. ■

Circle 206 on card or click "PTEN e-inquiry" on VehicleServicePros.com



### REMOVES SHEPPARD PITMAN ARMS

The **Specialty Products Company Class 8 Pitman Arm Popper**, No. 73140, is designed to remove Sheppard pitman arms for short sector and long sector shafts with a bolt or nut attachment. The heat-treated pusher screw features fine threads and a ball bearing tip to make removal easier without damaging expensive steering box components. ■

Circle 209 on card or click "PTEN e-inquiry" on VehicleServicePros.com



FOR MORE INFORMATION ON THESE PRODUCTS,  
CLICK ON "PTEN E-INQUIRY"  
at [VehicleServicePros.com](http://VehicleServicePros.com)  
OR CIRCLE THE NUMBER ON THE CARD.



### UNIVERSAL FOR LIGHT AND HEAVY DUTY DIESEL ENGINES

The **Mueller-Kueps NOX Sensor Thread Restorer Kit**, No. 506 021, is designed to allow technicians to professionally restore the NOX sensor hole thread without damaging the exhaust system. The kit is universal for light and heavy duty diesel engines. It features an alignment guide at the front of the restorer to ensure proper angle and is extra short, enabling it to be used with a socket or ratchet spanner for narrow spaces. The time-saving tool can also be used for the diesel particulate filter as well as any exhaust sensor, even those located in a catalytic converter. Available in sizes M20 x 1.5 and M22 x 1.5. ■

Circle 210 on card or click "PTEN e-inquiry" on [VehicleServicePros.com](http://VehicleServicePros.com)



### QUICKLY INSTALLS U-JOINT BEARING CUPS ON 1610-1880 SERIES YOKES

The **Cal-Van Tools Bolt Retainer Cup Installer**, No. 18510, is designed to make fast and easy work of installing bolt retained bearing cups of 1610 to 1880 series full-round yokes commonly found on Class 6 to Class 8 vehicles. It uses the bolt holes of the flange to ensure proper alignment of the cup and eliminates damage to cups, seals, and needle bearings. ■

Circle 211 on card or click "PTEN e-inquiry" on [VehicleServicePros.com](http://VehicleServicePros.com)

SPONSORED  
Circle 212 on card or click "PTEN e-inquiry" on [VehicleServicePros.com](http://VehicleServicePros.com)

## FEATURED PRODUCT



### FOCUSES ON GENERATION 1, 2, 3, AND 4 X 4 WHEEL BEARING REPLACEMENT

**Pacific Automotive Industries** offers professional quality, time saving **On-Car Bearing Removal and Replacement Tools**. Made in Europe by Wallmek tools, the product offering focuses on Generation

1, 2, 3, and 4 x 4 wheel bearing replacement. Hydraulic rams for demounting hubs on cars come in sizes ranging from 18 tons to 32 tons. The world's finest quality CNC

machined air over hydraulic foot pump rounds out the product offering. ■



**Pacific Automotive**  
951-229-7617  
[pacautoind.com](http://pacautoind.com)

### CAN BE USED ON MOST DOMESTIC AND IMPORTED VEHICLES

The **VIM Tools Hub and Stud Cleaning Kit for Cars**, No. HSC100, includes the HSC1 Hub and Stud cleaning tool with a 1/4" Hex to 1/2" square adapter, the HCP15 4-pack 15mm hub cleaning pads, and SCB14 4-pack 14mm stud cleaning wire brush. The HCS1 can be used with a drill or impact wrench and has a quick-lock system for switching heads easily. The HCP15 removes rust and grime from the wheel hub surface and helps prevent brake rotor warping. The SCB14 also removes rust and grime from wheel studs and can prevent lug nuts from seizing and cross threading. The set can be used on most domestic and imported vehicles. ■

Circle 213 on card or click "PTEN e-inquiry" on [VehicleServicePros.com](http://VehicleServicePros.com)



### DOESN'T COMPROMISE THE STEERING BOX POSITION

The **Schley Products Updated Low-Profile Pitman Arm Remover**, No. 68800A, incorporates improvements that make it similar in design to Schley Product's larger 11880, which utilizes an integrated dog bone design and gold zinc hardware. The 68800A quickly and easily removes the pitman arm from most steering gearboxes equipped with a worm and sector shaft design. It performs this operation without compromising the steering box position or

requiring the removal of the entire steering gear assembly in order to remove the pitman

arm. The 68800A is engineered to work on vehicles with steering boxes having a maximum dimension on the sector shaft of 1.5" and a pitman arm that is no larger than 2.6" wide. ■

Circle 214 on card or click "PTEN e-inquiry" on [VehicleServicePros.com](http://VehicleServicePros.com)



SPONSORED

Circle 215 on card or click "PTEN e-inquiry" on VehicleServicePros.com

## FEATURED PRODUCT

### PROVIDES FULL CHASSIS DIMENSIONING

The **Coats CWA 6500 3D Diagnostic Wheel Alignment System** features an automatic power tracking camera boom to keep the high definition cameras focused on the targets, enabling fast and accurate alignments. The black diamond mini targets are low profile and easy to handle. The aligner offers full chassis dimensioning, including wheelbase, setback, rolling radius, and all cross measurements are available on one large, moveable LCD screen. The CWA 6500 also includes features such as a VIN scanner and patented QC20 tire clamps which prevent damage to alloy wheels. ■



**coats**  
www.coatsgarage.com

### REPLACES BRAKE SHOES ON HEAVY DUTY TRACTOR AND TRAILER S-CAM BRAKES

The **Lisle Corporation Brake Spring Bar**, No. 40030, replaces brake shoes on heavy duty tractor and trailer S-Cam brakes. To remove the spring, slip the hook into the retaining spring loop and press down against the axle. The Brake Spring Bar levers action against the axle to eliminate the need for wrenches, pry bars, and screwdrivers. The tool is 18" long with a molded handle for comfort and has a black oxide finish. ■

Circle 216 on card or click "PTEN e-inquiry" on VehicleServicePros.com



### FEATURES ALL METAL CONSTRUCTION ADAPTERS

The **CTA Manufacturing 11-pc Pro-Series Brake Bleeding Adapter Set**, No. 3930, features all metal construction adapters. It services many late model domestic, Euro, and Asian vehicles. Most of the adapters have a 90-degree swivel connection fitting for when space is limited. The set is designed to work with CTA's Pressure Bleeder Tank, No. 7015, but not limited to. The adapters come equipped with standard European (Nitto) fittings, but also include a standard National (Milton) fitting adapter for use with other pressure bleeder tanks. ■

Circle 217 on card or click "PTEN e-inquiry" on VehicleServicePros.com



## MARKETPLACE

Contact James Hwang at [JHwang@EndeavorB2B.com](mailto:JHwang@EndeavorB2B.com) for advertising information.

**Use All the Tools of the Trade!**

Professional Tool & Equipment News offers a wide variety of classified opportunities just waiting for you!

Contact James Hwang for more information:  
949.933.94189  
[Jhwang@endeavorb2b.com](mailto:Jhwang@endeavorb2b.com)



## TURN YOUR TOOL IDEA INTO MONEY

**LISLE CORPORATION CURRENTLY PAYS ROYALTIES TO OVER 120 INDIVIDUALS.**

Lisle has been in business for over 110 years and for over 40 years have been working with individuals on an award or royalty basis. If you have an original tool idea which others may need, we have a procedure to evaluate your idea.



Respond now to request an idea disclosure packet.

P.O. Box 89 • Clarinda, IA 51632-0089  
712-542-5101 • Fax 712-542-6591  
[www.lislecorp.com/about/program](http://www.lislecorp.com/about/program)

### QUICKLY REMOVES THE RACE FROM HUB

**Steck Manufacturing's Inner Race Hub Saver**

is a 6" steel cone with an integrated bearing in its base to allow a technician to place the hub on the tip of the cone and rotate the hub with one hand while applying heat from an oxyacetylene torch. While rotating the hub, the oxyacetylene torch will raise the temperature of the inner bearing race evenly and quickly, a few hundred degrees, causing the race to expand and release from the hub due to its tight tolerance. ■

Circle 218 on card or click "PTEN e-inquiry" on VehicleServicePros.com



# ALL THE TOOLS YOU NEED IN ONE PLACE!



Call Now for  
**FREE** catalog!

or visit [www.wrenchers.com](http://www.wrenchers.com)

Shop Equipment | Automotive Tools | Car Lifts | Wheel Service

Ask about our price promise guarantee.

Circle 219 on card or click "PTEN e-inquiry" on [VehicleServicePros.com](http://VehicleServicePros.com)

**1-800-261-7729**

© 2022 Wrenchers LLC. All Rights Reserved.

**WRENCHERS**™

# HIGH QUALITY SHOP FANS

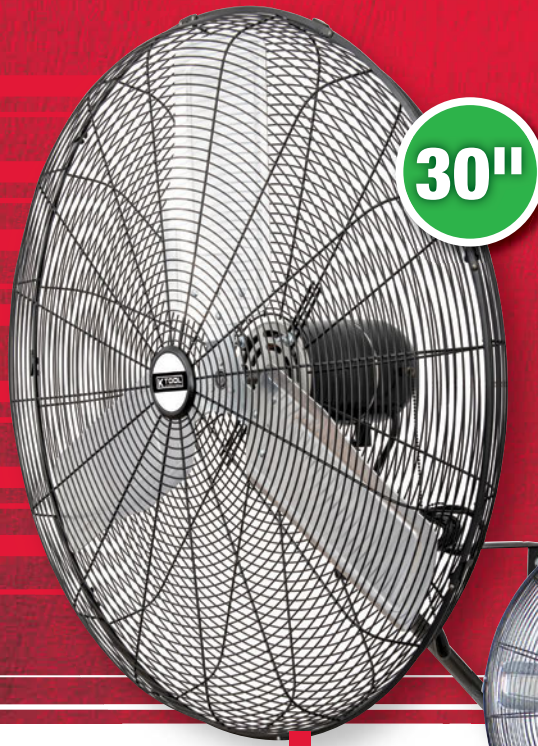

**KTI77732**

## **30" OSCILLATING WALL MOUNT INDUSTRIAL FAN**

- 3-Speeds: 7930CFM (High), 6144CFM (Medium), 2880CFM (Low)
  - 3 blade construction for maximum cooling plus pre-punched holes for ease of mounting
- Non-Oscillating Version Available: KTI77731*

**KTI77734**

## **30" OSCILLATING PEDESTAL INDUSTRIAL FAN**

- 3-Speeds: 5320CFM (High), 4272CFM (Medium), 2880CFM (Low)
  - 3-blade aluminum design provides even airflow for quiet operation
  - Height adjustment up to 76 inches
- Non-Oscillating Version Available: KTI77730*



**NEED MORE FANS? Visit [www.ktoolinternational.com](http://www.ktoolinternational.com)**



Circle 220 on card or click "PTEN e-inquiry" on [VehicleServicePros.com](http://VehicleServicePros.com)

## **HEAVYWEIGHT QUALITY. KNOCKOUT PRICE.**

K-Tool is the leader in innovative, high quality products at a price you can afford. Ask your Tool Dealer about the full line of K-Tool products available. All covered by a 1 year warranty on material and workmanship.

